

Sports Medicine

2020 Catalog



CONFIDENTIAL material for the Zimmer Biomet sales force, employees, and authorized representatives.

Loaner Set Information

Loaner Set No.	Description
SM_989100_L	Propeller Screw Loaner
SM_989101_L	Medial Portal Aimers
SM_989102_L	Double Bundle Instruments
SM_989103_L	Graft Prep Table
SM_989104_L	Prelude® PF Instruments
SM_989105_L	Bone Tendon Bone Instruments
SM_989106_L	Storz Graft Prep Table
SM_989107_L	Hip Arthroscopy Set
SM_989108_L	Sta-Flex® Subtalar Screw
SM_989109_L	New Bone Mulch™/Washer
SM_989110_L	Gentle Threads™ Loaner
SM_989111_L	Modular PCL Loaner
SM_989112_L	Modular ACL/PCL Loaner, Fanelli
SM_989112R_L	ACL/PCL Revision Loaner
SM_989125_L	Shoulder Traction Device
SM_989126_L	Repicci Femoral/Inlay
SM_989135_L	C2000 Leg Positioner
SM_989199_L	WasherLoc Loaner Instrument
SM_989200_L	Graft Tensioner Loaner
SM_989339_L	MaxFire™ Meniscal Loaner
SM_989400_L	Resorb No-Profile S & W
SM_989465_L	No-Profile Scrw & Washer
SM_989486_L	Repicci II® Knee Turbo
SM_989510_L	Charlotte Shoulder Set
SM_989512_L	Precision II Knee Hand Set
SM_989513_L	CSS Tray, 3 Only

Loaner Set No.	Description
SM_989514_L	Precision Flexible ACL
SM_989681_L	Maxfire Meniscal Repair
SM_989682_L	Repicci Inlay & Femoral
SM_989685_L	Repicci Mod & Femoral
SM_989686_L	Repicci Onlay & Femoral
SM_989710_L	Modular Bone Dowel Loaner
SM_989740_L	Curvtek® Handpiece with HO
SM_989760_L	Bone Mulch Loaner Tray
SM_989761_L	Modular Loaner Set
SM_989762_L	Interference Screw Loaner
SM_989766_L	Axl Crosspin Loaner Set
SM_989767_L	EzLoc Washerloc Loaner
SM_989800_L	Arthrorivet™ Loaner Instruments
SM_989900_L	ReUnite® Pin System Loaner
SM_989910_L	Small Resorb Screw System
SM_989920_L	Large Resorb Screw System
SM_989930_L	Rattler Interference Screw Loaner Set
SM_989940_L	LactoNail® Bone Fixation
SM_989949_L	JuggerKnot 1-4 Short
SM_989127_L	Repicci Onlay Instrument
SM_989128_L	Repicci Modular Tibial Instrument Does Not Contain 5/16 Drill Bit w/Stop
SM_989516_L	Switchcut ACL Reaming System
SM_989679_L	Prelude Patella Implants
SM_989680_L	Prelude PF Femoral Implants
SM_989511_L	Charlotte Shlder with PII Hand Ins

All trademarks herein are property of Zimmer Biomet Sports Medicine, unless otherwise indicated.

Table of Contents

Click on product or page number to jump to that page,
click on bottom right button to jump back to this page.

Sample Products	6 - 8
Knees	10 - 58
Knee Instrumentation	10-37
Precision Flexible Reaming System	10
SwitchCut™ Reaming System.....	14
ACL Tibial Instruments.....	16
Fanelli™ PCL/ACL Guide	22
Medial Portal Instruments	24
Transtibial ACL Instruments	26
General Knee Instrumentation.....	27
ACL/PCL Implants	38 - 58
EZLoc™ Femoral Fixation Device	38
ToggleLoc™ Femoral Fixation	39
Interference Screws (Implants/Instruments).....	43
WasherLoc™ Tibial Fixation Device	48
TunnelLoc® Interference Screw System.....	50
AperFix® System	53
iFix® Interference Screws	57
AFX® Femoral Implant.....	58
Meniscus	59 - 61
JuggerStitch™ Meniscal Repair Device	59
CrossFix® II System	61
Hips	62 - 71
JuggerKnot® Long Soft Anchor	62
SureLock® All-Suture Anchor.....	63
Quattro® GL/GL2 Suture Anchors.....	64
SpeedSnare™ Surgical Suture Passer	66
Dragon Tongue Suture Passer	67
Hip Systems Trays	68

Table of Contents (cont.)

Suture	72 - 75
Upper Extremities	76 - 96
Shoulder Rotator Cuff Repair	76 - 83
Ventix™ Link Knotless Anchor	76
Quattro Link Knotless Anchor	77
Quattro X Suture Anchors.....	78
ComposiTCP Suture Anchor	79
ALLthread™ Suture Anchors	80
JuggerKnot Soft Anchor 2.9 mm	81
SureLock® All Suture Anchors	82
BioWick® SureLock Implant.....	83
Shoulder Labral Repair	84 - 89
Quattro Link Knotless Anchors	84
Quattro GL/GL2 Suture Anchors	85
JuggerKnot Soft Anchors 1.4 mm & 1.5 mm	86
SureLock All Suture Anchors 1.4 mm	88
JuggerKnotless® Soft Anchor 2.1 mm	89
AC Joint Reconstruction/Reduction	90 - 97
ZipTight™ Ankle Fixation System.....	90
Proximal Biceps	91 - 97
Quattro Bolt Tenodesis Screws	91
ToggleLoc 2.9 mm Soft Tissue Fixation System	92
ToggleLoc Elbow 4.5 mm Fixation System	93
JuggerLoc™ Pull Through 2.3 mm Fixation System	94
JuggerLoc™ Unicortical 2.9 mm Fixation System.....	95
SnapShot™ Fixation System	96

Table of Contents (cont.)

Small Bone & Joint	97 - 99
JuggerKnot Soft Anchor 1.0 mm	97
JuggerKnot 1.4 mm Short	98
JuggerKnot 1.45 mm Rigid.....	99
Suture Passing Instrumentation	100 - 103
Quattro Suture Passers.....	100
Lock-Stitch® Suture Passer	101
EZPass™ Suture Passing System	102
SpeedSnare Suture Passer System.....	103
Upper Extremities General Instrumentation	104 - 110
Shoulder Instrumentation Trays.....	104
Precision II ArthroPasser™ Suture Passers.....	105
Penetrating Suture Graspers	105
Tissue Graspers.....	106
Legacy (PII) Biters.....	107
Bone and Tissue Preparation	108
Suture Management.....	109
Fluid Management	111 - 113
HydroDam™ Cannula System	111
Absorb-O-Mat® OR Floor Mat*	113
Capital Equipment	114
InnerVue™ Diagnostic Scope System	114

*Absorb-O-Mat® OR Floor Mat is a trademark of Pioneer Medical, Inc.

Sample Products

Knees

Part Number	Description
904780S	7-8 mm EZLoc Femoral Fixation Device Sample
904781S	9-10 mm EZLoc Femoral Fixation Device Sample
904780D	EZLoc Demo Bone with Connect Sample
904755S	#7 PE ZipLoop Extended ToggleLoc Sample
110005087S	ToggleLoc with ZipLoop Inline Sample
110005089S	ToggleLoc XL with ZipLoop Sample
110005090S	ToggleLoc XL Inline Sample
904720D	ToggleLoc Demo Bone Sample
900325S	Side Load Disposable MaxCutter Sample
907325S	10.5 x 25 mm Bone Mulch Screw +5 Tip Sample
905601S	7 x 25 mm Gentle Thread Fully Threaded Sample
905613S	7 x 25 mm Gentle Thread Round Head Sample
905626S	12 mm Gentle Threads Interference Screw Sample
909674S	9 x 20 mm Round Head Interference Screw Sample
909675S	9 x 20 mm Fully Threaded Interference Screw Sample
908436D	WasherLoc Demo Bone with Connect Sample
908436S	16 mm WasherLoc Tissue Fixation Sample
908632S	WasherLoc Screw Sample
908846S	6 x 46 mm Cancellous Screw Sample
906512S	8 mm TunneLoc Implant Sample
906514S	10 mm TunneLoc Implant Sample
906515S	11 mm TunneLoc Implant Sample
110024772S	JuggerStitch Meniscal Repair Device Sample
110024773S	JuggerStitch Meniscal Repair Device Curved Sample
MK1074202	29 mm AperFix Construct Sample
MK1074203	AperFix AM Construct Sample
MK1074204	AFX Construct Sample
MK1080501	29 mm AperFix Implant, PEEK Implant Sample
MK1136302B	29 mm AperFix Femoral System, PEEK Implant and Inserter Sample
MK11398	10 x 30 mm AperFix Tibial Screw Sample
MK11510B	10 x 30 mm AperFix Tibial System Sample
MK11555	10 x 30 mm AperFix Tibial Sheath Assembly Sample
MK20372	iFix Screw, BTB Screw Sample
MK60066	CrossFix Probe, Meniscal Probe Sample
MK6025001	CrossFix Meniscal Repair Device, Meniscal Size 0 Suture Implant Sample
MK6025002	CrossFix Dummy Device, Meniscal Device Sample (Does Not Include Suture)
MK60400B	CrossFix Meniscal Tools, Meniscal Knot Pusher/Suture Cutter and Introducer Sample

Sample Products (cont.)

Hips

Part Number	Description
916030S	JuggerKnot Long, #1 MaxBraid Implant Sample
110002756	JuggerKnot Long, #2 MaxBraid Implant Sample
110002757	JuggerKnot Long, #2 MaxBraid Sample Reload (5 Pack)
110002758	JuggerKnot Long, #1 MaxBraid Sample Reload (5 Pack)
916020S	JuggerKnot Hip Kit Curved Sample
916040S	JuggerKnot Long Soft Anchor Sample Set
MK3400003	2.9 mm Quattro GL Suture Anchor, Suture Loaded Anchor with Inserter Sample

Shoulders

Part Number	Description
905940S	5.5 ALLthread L15 Cutting Needles Sample
905942LS	5.5 ALLthread L15 (2) #2 MaxBraid Lab Sample
905942PLS	5.5 ALLthread Peek (2) #2 MaxBraid Sample
905942PS	5.5 ALLthread Peek (2) #2 MaxBraid Sample
905942S	5.5 ALLthread L15 (2) #2 MaxBraid Sample
905943PS	5.5 ALLthread Peek (2) #2 MaxBraid Needles Sample
905944PS	6.8 ALLthread Peek (2) #2 MaxBraid Sample
905944S	6.8 ALLthread L15 (2) #2 MaxBraid Sample
902592S	6.5 ALLthread Ti (2) #2 MaxBraid Sample
902570S	3.0 mm TI-Screw ES Sample (1 Pack)
902571S	5.0 mm TI Screw ES Sample (1 Pack)
902572S	5.0 mm TI-Screw ES Sample (1 Pack)
905570S	3.5 mm LactoScrew™ with MaxBraid Sample
905572S	5.5 mm Anchor with MaxBraid No Needle Sample
912030S	1.4 mm JuggerKnot Sample
912030SR	1.4 mm JuggerKnot Reload Sample (10 Pack)
110025876S	1.4 mm JuggerKnot with #1 Blue MaxBraid Sample
110025820S	1.4 mm JuggerKnot Non-Sliding Size 1 MaxBraid Sample
110025821S	1.4 mm JuggerKnot Non-Sliding Size 2 MaxBraid Sample
110025822S	1.4 mm JuggerKnot Short Non-Sliding Size 1 MaxBraid Sample
110025823S	1.4 mm JuggerKnot Short Non-Sliding Size 2 MaxBraid Sample
912040S	1.4 mm JuggerKnot Disposable Kit Sample
912040PS	JuggerKnot Percutaneous Kit Sample
912040CS	JuggerKnot Curved Kit Sample
912031S	1.5 mm JuggerKnot Sample
912031SR	1.5 mm JuggerKnot Reload Sample (10 Pack)
110025877S	1.5 mm JuggerKnot with #2 Blue MaxBraid Sample
912041S	1.5 mm JuggerKnot Disposable Kit Sample

Sample Products (cont.)

Shoulders (cont.)

Part Number	Description
110025772S	1.8 mm JuggerKnot Double MaxBraid Sample
110025773S	1.8 mm JuggerKnot Double MaxBraid Tapered Needle Sample
110025774S	1.8 mm JuggerKnot Double MaxBraid Cutting Needle Sample
110025769S	2.1 mm JuggerKnot Triple MaxBraid Sample
110025770S	2.1 mm JuggerKnot Triple MaxBraid Tapered Needle Sample
110025771S	2.1 mm JuggerKnot Triple MaxBraid Cutting Needle Sample
912029S	2.9 mm JuggerKnot Blue Sample Implant
912029SR	2.9 mm JuggerKnot Blue Reload Sample (5 Pack)
912050S	2.9 mm JuggerKnot Sample Implant
912050SR	2.9 mm JuggerKnot Reload Sample (5 Pack)
110005198S	JuggerKnotless SS Inserter Sample
110005200	JuggerKnotless Reload Sample (5 Pack)
110003165	JuggerKnotless Implant Sample
110003168	JuggerKnotless Needles Sample
110009764	JuggerKnotless Straight Sample Kit
110009765	JuggerKnotless Flexible Disposable Sample Kit
904834S	ZipTight Acute Sample
904835S	ZipTight AC Chronic Sample
110018165S	SnapShot Full Kit Sample
110018166S	SnapShot Reload Sample
110017308S	2.9 mm ToggleLoc with Needles Sample
110010384S	2.9 mm ToggleLoc Sample
110029966S	2.9 mm ToggleLoc without Needles Reload Sample (3 Pack)
110029967S	2.9 mm ToggleLoc with Needles Reload Sample (3 Pack)
110017362S	2.3 mm JuggerLoc Soft Tissue Pull Through Sample
110010382S	2.3 mm JuggerLoc with Needles Pull Through Sample
110010381S	2.9 mm JuggerLoc Soft Tissue Fixation Device Sample
110017358S	JuggerLoc Soft Tissue Fixation with Needles Sample
110007337S	JuggerLoc BTB Round SS Kit Sample
110007345S	JuggerLoc BTB TI Implant Kit Sample
110007346S	JuggerLoc SS BTN Sample
110017314S	2.9 mm JuggerLoc Unicortical Fixation Sample
110010372S	7.0 mm JuggerLoc Slotted Reamer Sample
110005243	2.9 mm JuggerKnot Cutting Needles Sample
110005244	2.9 mm JuggerKnot Tapered Needles Sample
110017271S	2.9 mm JuggerLoc Guide Pin Sample
110010385S	JuggerLoc Instrumentation Sample Kit
110010861	Disposable Nitinol Needle Sample

Sample Products (cont.)

Shoulders (cont.)

Part Number	Description
MK3407202	2.9 mm Quattro Link Knotless Anchor with Inserter Sample
MK7002005	5.5 mm Quattro X Suture Loaded Anchor with Inserter Sample
MK7002006	6.5 mm Quattro X Suture Loaded Anchor with Inserter Sample
MK7007804	4.5 mm Quattro Link Knotless Anchor with Inserter Sample
MK7007805	5.5 mm Quattro Link Knotless Anchor with Inserter Sample
MK7007806	4.5 mm Quattro Link SP Knotless Anchor with Inserter Sample
MK70399	4.5 mm Quattro Link Knotless Anchors ONLY Sample
MK70402	4.5 mm Quattro Link SP Knotless Anchors ONLY Sample
MK71253	5.5 mm BioWick X Implant in Model Sample (Implant Deployed in Clear Block)
MK71254	5.5 mm BioWick X Implant Sample (Scaffold Wick Implant)
MK8021401	1.4 mm SureLock Suture Anchor Sample
MK8049701	2.7 mm BioWick SureLock Implant Sample (Scaffold Wick Implant)
MK7130001	4.75 mm Ventix Link Knotless implant with inserter Sample
MK7129901	4.75 mm Ventix Link Knotless Sample (2 pack, Anchor Reload Only)
MK7128701	5.5 mm Quattro X Suture Anchor, BB Double Loaded Anchor with Inserter Both Sliding Sample
MK7128702	5.5 mm Quattro X Suture Anchor, BB Double Loaded Anchor with Inserter One Non-Sliding Sample

Suture Management

Part Number	Description
110007381	EZPass 90 Degree Up Sample
110007382	EZPass 45 Degree Up Sample
110007383	EZPass 45 Degree Dog Leg Up Sample
110007384	EZPass 70 Degree Right Sample
110007385	EZPass 70 Degree Left Sample
110007386	EZPass 30 Degree Right Sample
110007387	EZPass 30 Degree Left Sample
MK70593	Lock-Stitch System TRU-LOOP, Suture Loop with Tail Sample

Hand, Wrist and Elbow

Part Number	Description
904753S	11 mm #7 PE ZipLoop ToggleLoc Elbow Sample
912076S	1.0 mm JuggerKnot Mini 2-0 Sample (3 Pack)
912082S	1.0 mm JuggerKnot Mini 3-0 Sample (3 Pack)
MK4018806	Quattro Bolt Anchor, 7.0 mm Tenodesis PEEK Screw Sample

Knee Instrument Systems

ACL Reconstruction – Precision

Precision Flexible ACL System Targeting Drill Case

Features

- Designed to meet the modern demands of tunnel preparation for an ACL Reconstruction
- Versatile system allows the ability to personalize the case depending upon the surgeon’s tunnel preference
- Four instrument caddies contain reusable guides or reamers
- Provides the ability to interchange the four caddies depending upon the desire for preparing the femoral or tibial tunnel

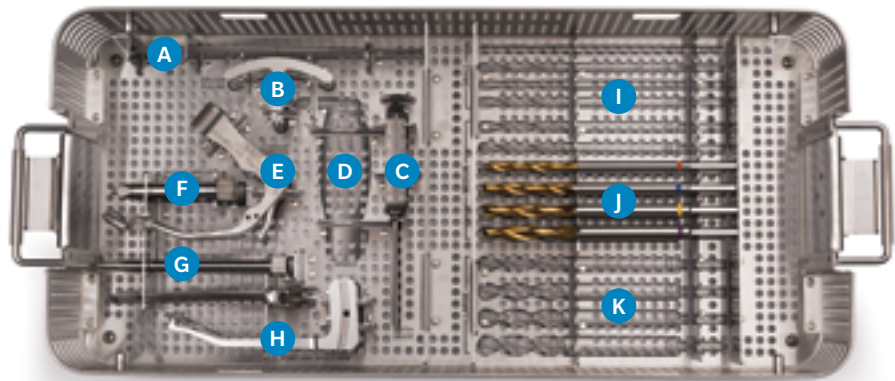

Precision Flexible ACL System Components	
110016869	Targeting Drill Case
909507	A Coronal Alignment Pin
904776	B ZipLoop Puller
110009768	C Depth Gauge-Precision
907765	D Dilator Handle
909601	E Anatomy Specific Tibial Guide
909602	F Anatomy Specific Bullet
909512	G Point & Shoot Bullet
909511	H Point & Shoot Tibial Guide
110010399	Point to Point Arm
110010400	Point to Hole Arm
	I Small Drills
	J Medium Drills
	K Large Drills

Educational Materials

Ref. Number	Description
0270.1-US-en-REV0716	All Inclusive ACL Brochure
0439.1-US-en-REV0516	ACL Targeting Drill & Implant Preparation Cases

Note: The cannulated drills can be mixed and matched with the corresponding dilators within sections I, J, and K. There are a total of 23 instruments, but only 13 locations available for placement within the case. You can personalize these sections per the surgeon’s needs.

ACL Reconstruction – Precision

Instrumentation for the Precision Flexible ACL System

Precision Implant Prep Case

110016870	Implant Preparation Case
900342	A Super MaxCutter
110010813	B Graft Sizing Block
904766	C ToggleLoc Depth Gauge
909871	D Osteotome
909791	E Rasp
906988	F Curette
909990	G Closed Tendon Stripper
909992	H Open Tendon Stripper
910078	I Suture Retriever
909827	J K-Wire 2.4 mm x 10"
909640	K 3/32" x 16" Guide Pin

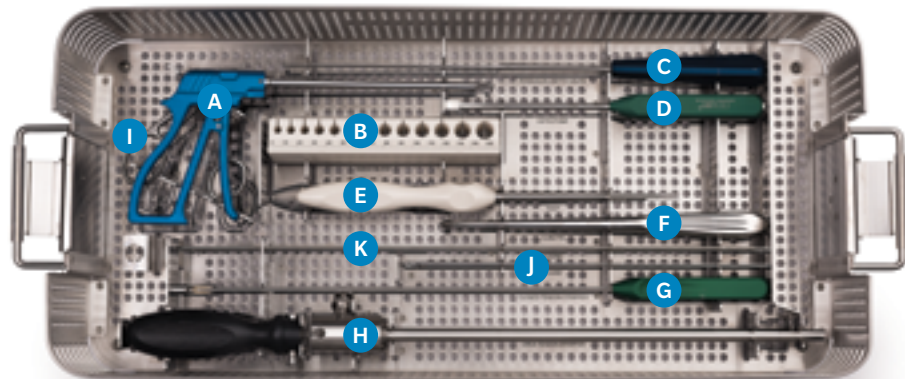

Precision IFS Tray

110016875	Interference Screw Tray
110004607	A ComposiTCP™ Driver, 7-8.0 mm
905274	B ComposiTCP Driver, 9-11.0 mm
909734	C Modular Easy Out, 2.5 mm
905656	D Gentle Threads Driver
110028400	E Gentle Threads Tunnel Dilator
110004597	F ComposiTCP Tap, 7-8.0 mm
905278	G ComposiTCP Tap, 9-11.0 mm
905650	H Gentle Threads Revision Driver
905652	I Gentle Threads Notcher
909733	J Ratchet Handle
906846	K Canulated Hex Driver, 3.5 mm
906845	L Canulated Hex Driver, 2.5 mm

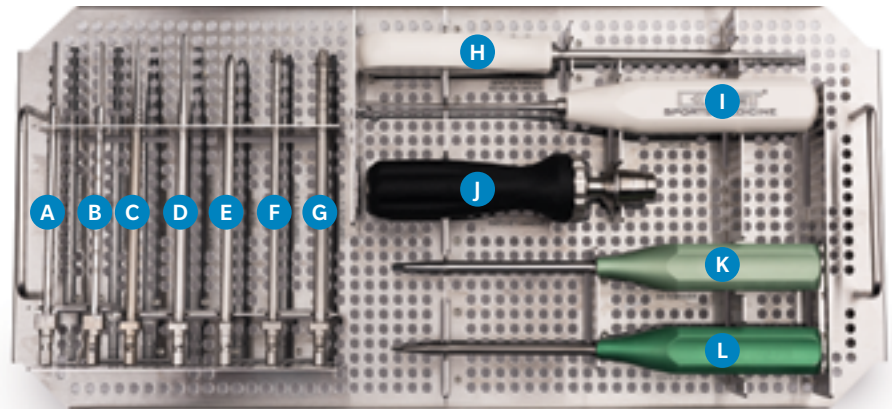

Precision WasherLoc Tray

110016876	WasherLoc Tray
900723	A Plunger, 8.0 mm
900718	B Collet, 8.0 mm
900743	C Dilator, 8.0 mm
900716	D Bone Dowel Handle
908433	E WasherLoc Depth Gauge
908437	F WasherLoc Drill Guide
908439	G WasherLoc Awl
908426	H WasherLoc Awl Guide
908427	I WasherLoc Countersink
904307	J Hex Driver, 3.5 mm

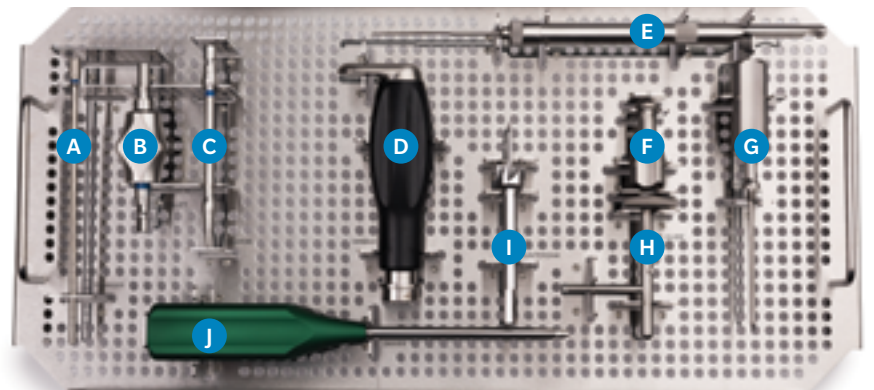

ACL Reconstruction – Precision

Precision Flexible Reamers

Features

- Two plane bend geometry allows the knee to stay at 90° and enters through a medial portal rather than an accessory medial portal
- Two alignment options limit the guesswork of the femoral tunnel
- Comprehensive sizing for flexible reamers and femoral guides

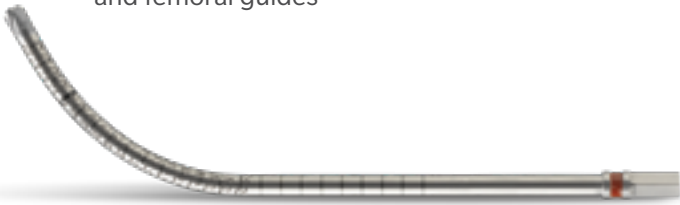

Precision Disposable Flexible Reamer	
110004180	4.5 mm
110004181	5.0 mm
110004182	5.5 mm
110004183	6.0 mm
110004184	6.5 mm
110004185	7.0 mm
110010577	7.5 mm
110004186	8.0 mm
110010578	8.5 mm
110004187	9.0 mm
110010579	9.5 mm
110004188	10.0 mm
110010580	10.5 mm
110004189	11.0 mm
110010581	11.5 mm

Educational Materials

Ref. Number	Description
0207.2-US-en	All Inclusive ACL Brochure
0439.1-US-en	ACL Targeting Drill & Implant Preparation Cases
0382.2-GLBL-en	Medial Portal ACL Reconstruction Surgical Technique
2413.1-GLBL-en	Precision BTB Surgical Technique

ACL Reconstruction – Precision

Instrumentation for the Precision Flexible ACL System



Precision Curved Aimer Caddy

110016872



Precision Rigid Reamer Caddy

110016873



Precision Rigid Aimer Caddy

110016874

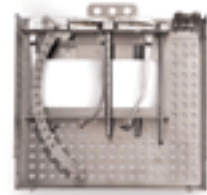

SwitchCut Caddy

110026911



Precision Femoral Aimers

- 110004074 7-8 mm Left
- 110004075 9-10 mm Left
- 110004076 11-12 mm Left
- 110004077 7-8 mm Right
- 110004078 9-10 mm Right
- 110004079 11-12 mm Right
- 110010621 5-6 mm Left
- 110010622 5-6 mm Right
- 110004080 Universal Left
- 110004081 Universal Right

Precision Medial Portal Femoral Aimer Handle

110004073



Modular Bio-Core™ Tap

- 905048 6 mm
- 905049 7 mm
- 905050 8 mm
- 905051 9 mm
- 905052 10 mm

Precision ACL Lid

110016877

2.1 mm Nitinol Guide Wire

- 110009769 Single
- 110008343 5 Pack



Cannulated Dilator Hex Drivers

- 907770 7 mm
- 907775 7.5 mm
- 907780 8 mm
- 907785 8.5 mm
- 907790 9 mm
- 907795 9.5 mm
- 907800 10 mm
- 907805 10.5 mm
- 907810 11 mm
- 907765 Handle

Note: Caddies and trays do not come with instruments. Instruments must be ordered separately.

ACL Reconstruction – SwitchCut Instruments

SwitchCut Reaming System

Features

- The SwitchCut Reaming System is created to be utilized for an outside-in approach
- System consists of left or right specific guide, bullet, and reamers with Nitinol passer



Instruments	
110026899	Universal Guide Body
110026900	Femoral Guide Arm Right
110026901	Femoral Guide Arm Left
110026903	Tibial Guide To Point
110026898	Guide Bullet 4.5 mm ID
110026902	Guide Bullet 6.0 mm ID
110026904	2.4 Drill Sleeve
110026881	PCL Guide Arm
110026882	Meniscal Root Guide Arm
110026880	ACL Point to Point Arm

Educational Materials

Ref. Number	Description
0270.1-US-en-REV0716	All Inclusive ACL Brochure
0180.1-US-en-REV0116	SwitchCut Reaming System for ACL Reconstruction
2029.1-GLBL-en	The iFix System Surgical Technique
1427.1-GLBL-en	SwitchCut All-Inside ACL Reconstruction Surgical Technique

ACL Reconstruction – SwitchCut Disposables

SwitchCut Reamer Kits

Features

- 6 to 12 mm reamer sizes, including half sizes
- Quick and easy deployment of reamer blade by simply switching power on the drill from forward to reverse
- Blade will deploy once it contacts bone in a reverse setting
- Cannulated reamers allow for passing of the Nitinol loop through the tunnel to assist in keeping tunnel placement



Disposables*	
110027674	4.5 x 6.0 mm
110027675	4.5 x 6.5 mm
110027676	4.5 x 7.0 mm
110027677	4.5 x 7.5 mm
110027678	4.5 x 8.0 mm
110027679	4.5 x 8.5 mm
110027680	4.5 x 9.0 mm
110027681	4.5 x 9.5 mm
110027682	4.5 x 10.0 mm
110027684	6 x 11.0 mm
110027686	6 x 12.0 mm
110026884	Loop Passer

*All reamers include a nitinol loop passer.

ACL Reconstruction – Guides

ACL Tibial Guides

Features

- Rigidly constructed guides allow for accurate pin placement
- Three options per surgeon preference
 - Point to Elbow
 - Point to Hole
 - Point to Point



Instruments	
909511	Point to Elbow Tibial Guide
909512	Point to Elbow Tibial Bullet
110010399	Point To Point ACL Guide
110010400	Point To Hole ACL Guide

Educational Materials

Ref. Number	Description
0270.1-US-en-REV0716	All Inclusive ACL Brochure

ACL Reconstruction – Guides

Modular ACL Guide

Features

- One ACL arm
- Two PCL arms, one right knee arm, one left knee arm
- Each PCL arm is designed to allow the PCL arm to have uninhibited placement when the ACL is intact
- Surgeon has ability to set angle and length of tunnels



Instruments	
909503	PCL Arm Left
909504	PCL Arm Right
909505	Modular ACL Guide*

Educational Materials

Ref. Number	Description
BSM0011.1	Modular ACL/PCL Guide Surgical Technique

*Includes the guide body and bullet

ACL Reconstruction – Guides

Instrumentation for the Modular PCL/ACL Guide



Modular Guide Wire
909894 2.4 mm x 13"

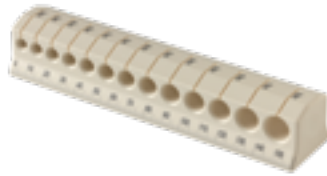

Graft Sizing Block
110010813



Femoral Aimer Handle
909623



**Fully Fluted
Cannulated Drill**

- 909911 7 mm
- 909913 8 mm
- 909915 9 mm
- 909917 10 mm
- 909919 11 mm
- 909921 12 mm



Drill Tip Guide Pin
(for Femoral Aimer)
909640 3/32" x 16"



**3.5 mm Cannulated
Screwdriver**
906846

Femoral Aimer Tip

- 909627 7 mm
- 909628 8 mm
- 909629 9 mm
- 909630 10 mm
- 909631 11 mm
- 909632 12 mm

Note: When you order a Femoral Aimer Tip, you receive the Ring Nut. You must order the handle in addition to the tip.



Acorn Reamers

- 909606 6.5 mm
- 909617 7 mm
- 909624 7.5 mm
- 909618 8 mm
- 909625 8.5 mm
- 909619 9 mm
- 909626 9.5 mm
- 909620 10 mm
- 909621 11 mm
- 909622 12 mm



**Graft Passing Pin/
Trocar Tip**
909634 3/32" x 16"

**Femoral Aimer
Replacement Ring Nut**

- 909627-03

ACL Reconstruction – Anatomy Specific Guides

Anatomy Specific Tibial Guide

Features

- Aids in the prevention of PCL impingement
- Aids in the prevention of roof impingement without performing a roofplasty
- Replication of the tension pattern of the intact ACL



Anatomy Specific Tibial	
909601	Anatomy Specific Tibial Guide
909602	Sharp Drill Guide Bullet-Calibrated
909507	Coronal Alignment Pin

Educational Materials

Ref. Number	Description
0383.1-GLBL-en-REV0516	Transtibial Surgical Technique for Placement of the Femoral Tunnel in the I.D.E.A.L.™ Position
BSM0015.1	EZLoc Femoral Fixation Device Instructional Foldout

ACL Reconstruction – Anatomy Specific Guides

Instrumentation for the Anatomy Specific Tibial Guide

EZLoc Instrument Trays

900767	EZLoc Tray #1
900768	EZLoc Tray #2
903740	Lid Generic Full



WasherLoc Instrument Sterilization Case

908435



Fully Fluted Cannulated Drill Bits

909909	6 mm
909910	6.5 mm
909911	7 mm
909912	7.5 mm
909913	8 mm
909914	8.5 mm
909915	9 mm
909916	9.5 mm
909917	10 mm
909919	11 mm
909921	12 mm
909923	13 mm

15° Angled Osteotome

909871



Partially Fluted Reamers

904773	6 mm
904767	7 mm
904768	8 mm
904769	9 mm
904770	10 mm
904771	11 mm

Guide Wires

Both wires are not needed for the Anatomy Specific Tibial Guide System. Either Guide wire may be used.

909827	Drill Point K-Wire
	2.4 mm x 10"

Curved Roofplasty Gouge

909873



Impingement Rods

909931	7 mm
909933	8 mm
909935	9 mm
909937	10 mm
909939	11 mm

Knee Microfracture Picks

909106	0°
909104	10°
909102	20°
909109	30°

ACL Reconstruction – Drills

Fully Fluted Cannulated Tibial Drills

Features

- Full thickness cannulated drills color-coded in 1mm increments for easy identification
- Used to create tibial tunnels for ACL or PCL reconstructions
- Sizing Sleeves can be used over the drill to protect soft tissue during drilling



Cannulated Drill	
909907	5 mm
909908	5.5 mm
909909	6 mm
909910	6.5 mm
909911	7 mm
909912	7.5 mm
909913	8 mm
909914	8.5 mm
909915	9 mm
909916	9.5 mm
909917	10 mm
909919	11 mm
909921	12 mm
909923	13 mm

Educational Materials

Ref. Number	Description
0383.1-GLBL-en-REV0516	Transtibial Surgical Technique for Placement of the Femoral Tunnel in the I.D.E.A.L. Position

PCL Reconstruction – Fanelli System

Fanelli PCL/ACL Guide

Features

- Adjustable guide facilitates accurate and reproducible tunnel placement for PCL and ACL reconstruction
- One guide used for both tibial and femoral tunnels in PCL reconstruction



Fanelli Guide	
909800	PCL Guide Body
909804	Bullet

Educational Materials

Ref. Number	Description
BSM0021.2	Fanelli PCL/ACL Guide Surgical Technique

ACL Reconstruction – Fanelli System

Instrumentation for the Fanelli PCL/ACL Guide



PCL Capsule Rasp

909790 **5 mm**



Hook Knife

909796 *(over the back)*



Graft Sizing Block

110010813



Trocac Tip Guide Pin

909634 **3/32 " x 16"**



Curved Rasp

909791



Tunnel Awl

909798



Acorn Reamer

909606 **6.5 mm**
 909617 **7 mm**
 909624 **7.5 mm**
 909618 **8 mm**
 909625 **8.5 mm**
 909619 **9 mm**
 909626 **9.5 mm**
 909620 **10 mm**
 909621 **11 mm**
 909622 **12 mm**



Drill Tip Guide Pin
(for Femoral Aimer)

909640 **3/32 " x 16"**



Cupped Curette

909792
 909793 *(over the back)*



Calibrated Probe

909799



Femoral Aimer Handle

909623



Double Bundle Aimers

909753 **5 mm**
 909754 **6 mm**
 909747 **7 mm**
 909748 **8 mm**
 909749 **9 mm**
 909750 **10 mm**



Open Curette

909794
 909795 *(over the back)*



Magellan™ Graft Passer
Used for PCL graft passage

909808

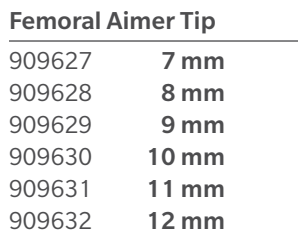

Femoral Aimer Tip

909627 **7 mm**
 909628 **8 mm**
 909629 **9 mm**
 909630 **10 mm**
 909631 **11 mm**
 909632 **12 mm**

Note: When you order a Femoral Aimer Tip, you receive the Ring Nut. You must order the handle in addition to the tip.

Fanelli Instrument Sterile Case

909810

Femoral Aimer Replacement Ring Nut

909627-03

ACL Reconstruction – Medial Portal

Acorn Reamer Aimer System

Features

- Acorn shape protects PCL during femoral tunnel drilling
- Calibrated in 5 mm increments to control tunnel depth
- Color-coded in 1 mm increments for easy identification



Aimer Systems	
909606	6.5 mm
909617	7 mm
909624	7.5 mm
909618	8 mm
909625	8.5 mm
909619	9 mm
909626	9.5 mm
909620	10 mm
909621	11 mm
909622	12 mm

Educational Materials

Ref. Number	Description
0383.1-GLBL-en-REV0516	Transtibial Surgical Technique for Placement of the Femoral Tunnel in the I.D.E.A.L. Position
BSM0013.1	Bone-Tendon-Bone Surgical Technique

ACL Reconstruction – Medial Portal

Instrumentation & Disposables for the Medial Portal



Medial Portal Aimers

909590	6 mm
909591	7 mm
909592	8 mm
909593	9 mm
909594	10 mm
909595	11 mm
909596	12 mm



Low Profile Reamers

906570	7 mm
906571	7.5 mm
906572	8 mm
906573	8.5 mm
906574	9 mm
906575	9.5 mm
906576	10 mm
906577	10.5 mm

Cayenne

Low Profile Reamers

CM-7609	9 mm, Sterile
CM-7610	10 mm, Sterile
CM-7611	11 mm, Sterile

ACL Reconstruction – Transtibial

Femoral Aimers

Features

- Size-specific Femoral Aimers allow for a reproducible 1 mm of posterior back wall
- Increasing size 1 mm with the Femoral Aimer will increase the posterior back wall 0.5 mm
- Color-coded in 1 mm increments for easy identification



Aimers	
909623	Handle
909627-03	Replacement Ring Nut
909627	7 mm Tip
909628	8 mm Tip
909629	9 mm Tip
909630	10 mm Tip
909631	11 mm Tip
909632	12 mm Tip
909633	13 mm Tip

Educational Materials

Ref. Number	Description
0383.1-GLBL-en-REV0516	Transtibial Surgical Technique for Placement of the Femoral Tunnel in the I.D.E.A.L. Position
BSM0013.1	Bone-Tendon-Bone Surgical Technique

ACL Reconstruction – Bone Coring

Autogenous Bone Coring System

Features

- Allows for the harvesting of bone plugs from both the tibial and transverse tunnels for later implantation in ACL surgery
- Position autogenous bone in femoral and tibial tunnels near the joint aperture
- Harvest a bone plug that can be used to replace the patella and tibial defects in Bone-Patellar-Tendon-Bone ACL reconstructions



Bone Dowel Instruments	
900717	7 mm Collet
900718	8 mm Collet
900719	9 mm Collet
900720	10 mm Collet
900721	11 mm Collet
900722	7 mm Plunger
900723	8 mm Plunger
900724	9 mm Plunger
900725	10 mm Plunger
900726	11 mm Plunger
900742	7 mm Dilator
900743	8 mm Dilator
900744	9 mm Dilator
900745	10 mm Dilator
900746	11 mm Dilator
900716	Handle Zimmer Hudson Adaptor

Educational Materials

Ref. Number	Description
BSM0025.2	Howell™ Bone Dowel Harvester Surgical Technique

ACL Reconstruction – Bone Coring

Instrumentation for the Autogenous Bone Coring System



Bone Dowel Handle

900716



Bone Dowel Plunger

900722	7 mm
900723	8 mm
900724	9 mm
900725	10 mm
900726	11 mm



**Coring Trephine
Autogenous Bone
Coring System**

900727	7 mm
900728	8 mm
900729	9 mm
900730	10 mm
900731	11 mm



**Dowel Harvest Tube
Autogenous Bone
Coring System**

900737	7 mm
900738	8 mm
900739	9 mm
900740	10 mm



Bone Dowel Collet

900717	7 mm
900718	8 mm
900719	9 mm
900720	10 mm
900721	11 mm



Bone Dowel Dilator

900742	7 mm
900743	8 mm
900744	9 mm
900745	10 mm
900746	11 mm

ACL Reconstruction – Guidewires

Disposable Guidewires



Disposables	
904764	3/32 x 13" EZLoc Etched Drill Pin
909540	3/32 x 16" Femoral Aimer Straight Guide Pin
909634	3/32 x 16" Trocar Tip Guide Pin
909640	3/32 x 16" Guide Pin for Femoral Aimer
909827	Drill Point K-Wire 2.4 mm x 10"
909894	3/32 x 13" Modular Guide Wire

ACL Reconstruction – Strippers

Tendon Strippers

Features

- Closed Ended stripper easily separates hamstring tendons from muscle attachments when grafts are detached from the distal tibia
- Open Ended stripper bluntly strips hamstring tendons from muscle attachments when grafts are left attached to the distal tibia



Instruments	
909990	Closed Tendon Stripper
909992	Open Ended Tendon Stripper
909993	Right Angled Clamp

ACL Reconstruction – BTB

Bone-Tendon-Bone Instrument System

Features

- Complete with graft harvest, tunnel and fixation instrumentation
- Accommodates either the Anatomy Specific Tibial Guide, Modular ACL/PCL Guide, or the Fanelli ACL/PCL guide
- Instrumentation for titanium TunneLoc interference screws or LactoSorb® Gentle Threads interference screws



BTB Instrument System	
909840	BTB Instrument Case
909884	8 mm Graft Cutting Template
909885	9 mm Graft Cutting Template
909886	10 mm Graft Cutting Template
906809	9 mm BTB Crimping Pliers
906810	10 mm BTB Crimping Pliers
909898	Patella Retractor

Educational Materials

Ref. Number	Description
BSM0013.1	Bone-Tendon-Bone Surgical Technique

ACL Reconstruction – BTB

Bone-Tendon-Bone Set Instruments



Howell 65° Tibial Guide
 909601 **Guide**
 909602 **Bullet**
 909507 **Coronal Alignment Rod**



Gentle Threads Screwdriver
 905650



Cannulated Hex Driver
 906846 **3.5 mm**



Graft Sizing Block
 906820



Fanelli PCL/ACL Guide
 909800 **Guide**
 909804 **PCL Bullet**



Gentle Threads Dilator
 905651



60° Curette
 906988



Lightning Pin Puller
 909510



Modular Guide
 909505 **Guide**
 909503 **PCL Arm Left**
 909504 **PCL Arm Right**



Gentle Threads Tunnel Notcher
 905652



Dilator Handle
 907765



Cannulated Acorn Reamer
 909617 **7 mm**
 909618 **8 mm**
 909619 **9 mm**
 909620 **10 mm**
 909621 **11 mm**
 909622 **12 mm**
 909616 **13 mm**



Point & Shoot Tibial Guide
 909511 **Guide**
 909512 **Bullet**



Gentle Threads Easy Out Screwdriver
 905654



Cannulated Tunnel Dilator
 907770 **7 mm**
 907775 **7.5 mm**
 907780 **8 mm**
 907785 **8.5 mm**
 907790 **9 mm**
 907795 **9.5 mm**
 907800 **10 mm**
 907805 **10.5 mm**
 907810 **11 mm**

All items listed on this page are part of the BTB Instrument Set



BTB Crimping Pliers

- 906809 **9 mm**
- 906810 **10 mm**

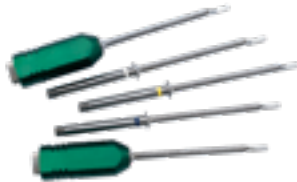

Femoral Aimer

- 909623 **Handle**
- 909627-03 **Replacement**
- Ring Nut**
- 909627 **7 mm Tip**
- 909628 **8 mm Tip**
- 909629 **9 mm Tip**
- 909630 **10 mm Tip**
- 909631 **11 mm Tip**
- 909632 **12 mm Tip**
- 909633 **13 mm Tip**



15° Angled Osteotome

- 909871



Patella Retractor

- 909898



Lollipop Inserter

- 906860 **Threaded**
- 2.4 mm x 9"**



Curved Rasp

- 909791



Curved Roofplasty Gouge

- 909873



Cannulated Drill Bit

- 909913 **8 mm**
- 909915 **9 mm**
- 909917 **10 mm**
- 909919 **11 mm**
- 909921 **12 mm**
- 909923 **13 mm**

Gentle Threads Disposable Kit

- 909826

Includes:

- 2.4 mm x 16" Graft Passing Pin Drill Tip
- 2.4 mm x 13" Drill Point K-Wire
- 1.5 mm x 14" Nitinol Guide Wire
- 1.1 mm x 9" Nitinol Guide Wire



BTB Graft Cutting Templates

- 909884 **8 mm**
- 909885 **9 mm**
- 909886 **10 mm**

All items listed on this page are part of the BTB Instrument Set

ACL Reconstruction – Graft Preparation

Graft Sizing Block

Features

- Allows for accurate sizing of ACL grafts
- Facilitates proper suture hole placement in bone plugs
- Slots act as a cutting template to shape bone plugs with a saw

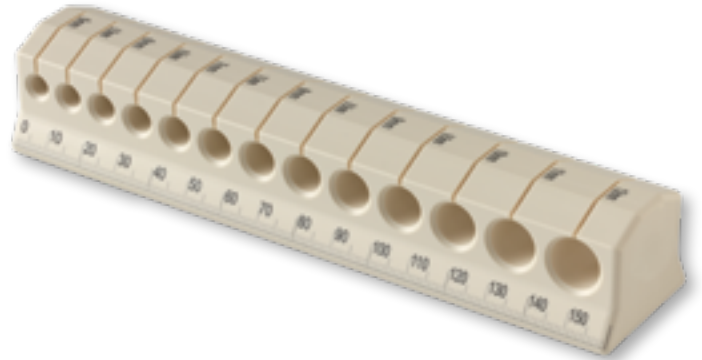

Sizing Blocks

110010813	Precision Graft Sizing Block
-----------	------------------------------

ACL Reconstruction – Graft Preparation

Tendon Board

Features

- Robust design and ease of use
- Adjustable for use in all-inside graft preparation
- Includes tensioning capabilities to limit graft creep

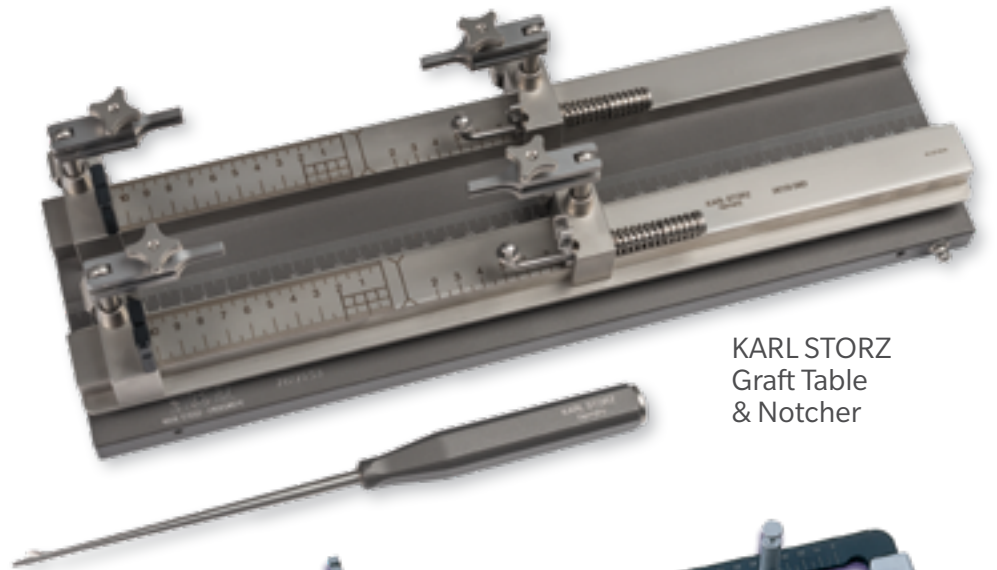

KARL STORZ
Graft Table
& Notcher

Instruments	
28729SB	Tendon Board with Fliptack Retainer
28729SBD	Tendon Board Add On
28729N	KARL STORZ Fin Shaped Notcher
904100	Biomet Sports Medicine Graft Preparation Table
904101	Biomet Sports Medicine Graft Preparation Table Tensioner



Educational Materials

Ref. Number	Description
0270.1-US-en-REV0716	All Inclusive ACL Brochure
1427.1-GLBL-en	SwitchCut All-Inside ACL Reconstruction Surgical Technique

ACL Reconstruction – Graft Preparation

ExpressBraid™ Graft Manipulation

Features

- Quick and easy graft preparation using a #2 MaxBraid suture
- The design of the needle crimped to suture facilitates a smooth passage through the graft
- Stiff needle promotes easy handling
- Two colors (co-braid and white) for easy identification of grafts

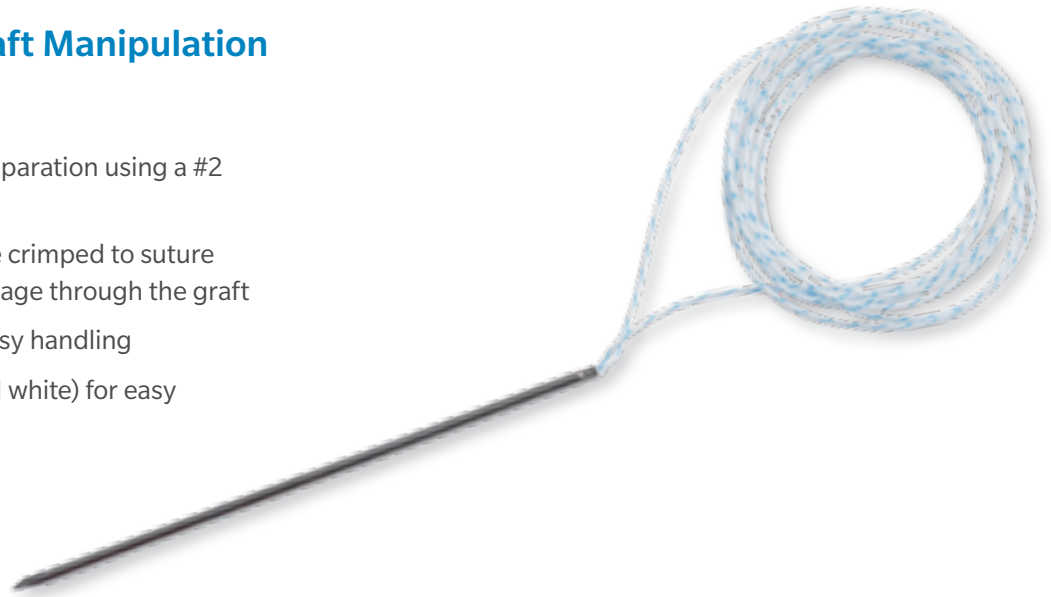

ExpressBraid	
110003540	Single White
110003539	Single Blue/White
110003538	Sample Blue/White
110003463	White (10 Pack)
110003464	Single Blue/White
110003464	Blue/White (10 Pack)

Educational Materials

Ref. Number	Description
0270.1-US-en-REV0716	All Inclusive ACL Brochure

ACL/PCL Fixation Devices – Instruments & Disposables

Modular Instrumentation and Disposables for ACL/PCL Kits



Disposable Lollipop Inserter

906860 **Threaded**
2.4 mm x 9"

Gentle Threads Interference Screw Disposable Kit

909826

Includes:

- 1.5 mm x 14" Nitinol Guide Wire
- 1.5 mm x 9" Nitinol Guide Wire
- 3/32" Femoral Aimer Guide Pin
- 3/32" Modular Guide Wire

EZLoc/WasherLoc Device Disposable Kit

909836

Includes:

- 3.2 mm x 5" Solid Drill Bit
- EZLoc Etched Guide Wire
- 2.4 mm Drill Point K-Wire

ToggleLoc/WasherLoc Device Disposable Kit

909846

Includes:

- 3.2 mm x 5" Solid Drill Bit
- 4.5 mm ToggleLoc Drill Bit
- EZLoc Etched Guide Wire
- 1.1 mm x 14" Nitinol Guide Wire
- 3/32" Femoral Aimer Guide Pin
- 2.4 mm Drill Point K-Wire

ACL Disposable Instrument Kit

110004136

Includes:

- Cannulated Bone Plug
- 1.1 Calibrated Nitinol Guide Wire
- Calibrated 3/32" x 16" Trocar Tip Femoral Guide Pin
- Graft Protector
- 2.4 mm Drill Point K-Wire

ToggleLoc Device with ZipLoop Technology Kit

909848

Includes:

- 3.2 mm x 5" Solid Drill Bit
- ToggleLoc Device with ZipLoop Technology
- 4.5 mm ToggleLoc Drill Bit
- 1.1 mm x 14" Nitinol Guide Wire
- 3/32" Femoral Aimer Guide Pin
- 3/32" Modular Guide Pin

ToggleLoc Device with ZipLoop Technology BTB Kit

909849

Includes:

- 3.2 mm x 5" Solid Drill Bit
- ToggleLoc Device with ZipLoop Technology with Continuous Loop for BTB
- 4.5 mm ToggleLoc Drill Bit
- 1.1 mm x 14" Nitinol Guide Wire
- 3/32" Femoral Aimer Guide Pin
- 3/32" Modular Guide Pin

ACL Fixation – Femoral Fixation

EZLoc Femoral Fixation Device

Features

- Simple technique featuring minimal steps
- Designed to maintain optimal stability and resist slippage
- Convenient disposable kit that includes EZLoc femoral pin and 3.2 mm WasherLoc drill

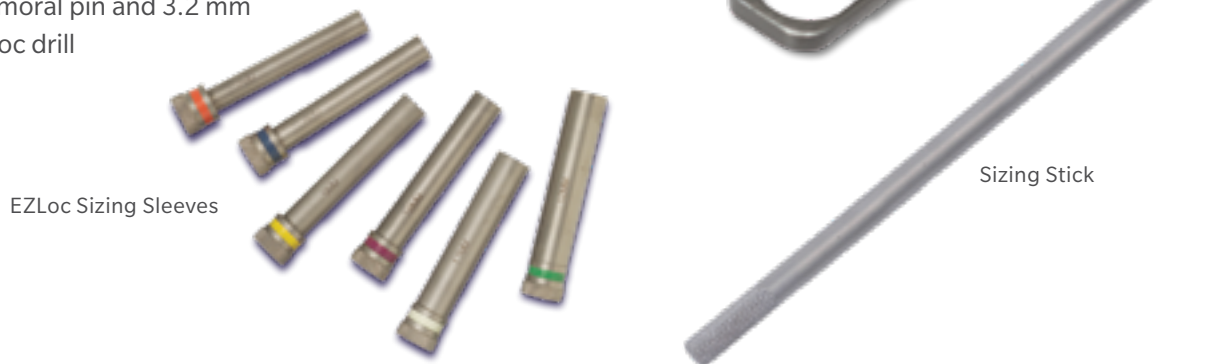

EZLoc Femoral Fixation Implants	
904762	7–8 mm Sizing Stick
904763	9–10 mm Sizing Stick
904780	7-8 mm Standard (12 mm)
904781	9-10 mm Standard (12 mm)
904784	7-8 mm Long (22 mm)
904785	9-10 mm Long (22 mm)
904788	7-8 mm Short (7 mm)
904789	9-10 mm Short (7 mm)
909811	7 mm EZLoc Sizing Sleeve
909813	8 mm EZLoc Sizing Sleeve
909815	9 mm EZLoc Sizing Sleeve
909817	10 mm EZLoc Sizing Sleeve
909819	11 mm EZLoc Sizing Sleeve
909821	12 mm EZLoc Sizing Sleeve
909836	EZLoc/WasherLoc Device Disposable Kit 3.2 mm x 5" Solid Drill Bit EZLoc Etched Guide Wire 2.4 mm Drill Point K-Wire ACL Bone Plug

Educational Materials

Ref. Number	Description
0270.1-US-en-REV0716	All Inclusive ACL Brochure
0383.1-GLBL-en-REV0516	Transtibial Surgical Technique for Placement of the Femoral Tunnel in the I.D.E.A.L. Position

Sample Products

Part Number	Description
904780S	7-8 mm EZLoc Sample
904781S	9-10 mm EZLoc Sample
904780D	EZLoc Demo Bone with Connect Sample

Adjustable Loops

ToggleLoc Femoral Fixation Device

Features

- First adjustable loop implant on the market
- One size implant fits all, eliminating the need for multiple sizing options
- Convenient disposable kit that includes 4.5 mm drill
- Inline: Ability to zip from the lateral thigh
- Inline: Reduces surgical steps by not having to pull the zipstrand out of the medial portal

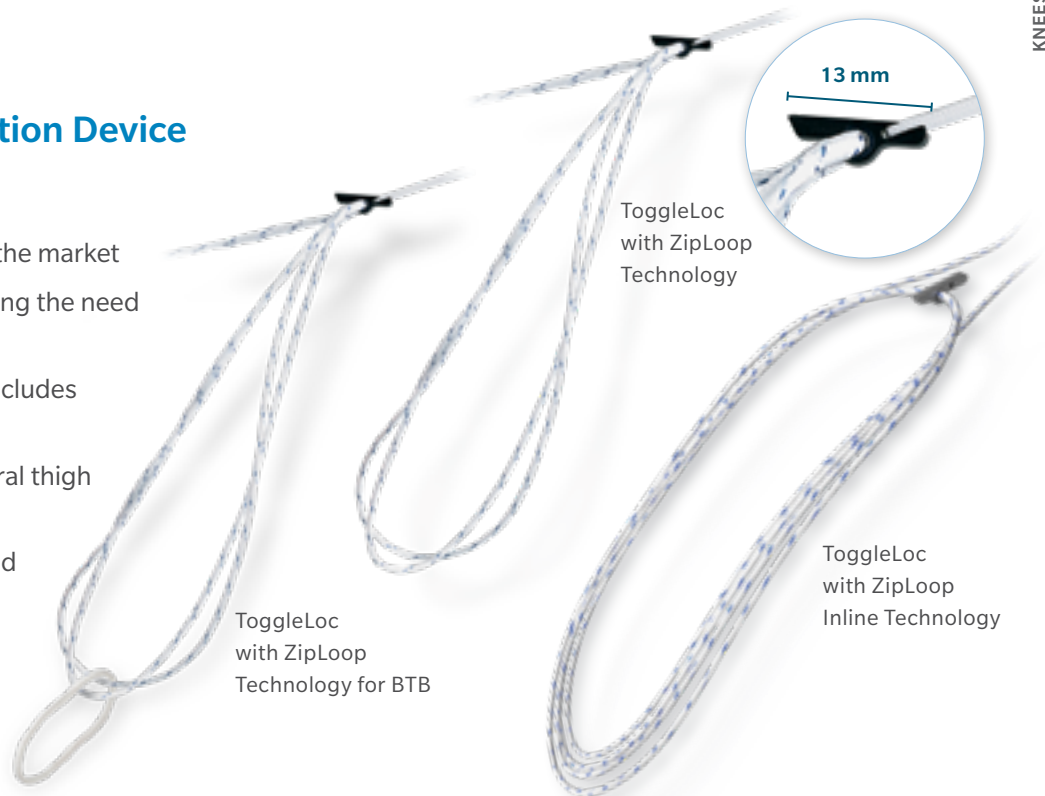

ToggleLoc Instruments Implants	
904754	ToggleLoc Fixation Device with ZipLoop Technology
904755	ToggleLoc Fixation Device with ZipLoop Technology (Extended Loop)
904756	ToggleLoc Fixation Device with ZipLoop Technology for BTB
110005087	ToggleLoc Fixation Device with ZipLoop Inline Technology

Educational Materials

Ref. Number	Description
2413.1-GLBL-en	BTB ToggleLoc with ZipLoop Surgical Technique
1427.1-GLBL-en	SwitchCut All-Inside ACL Reconstruction Surgical Technique
0405.1-GLBL-en	Medial Portal ToggleLoc Fixation Device with CompositTCP Interference Screws
1683.1-GLBL-en	ToggleLoc and ToggleLoc XL ACL Reconstruction

Sample Products

Part Number	Description
904755S	#7 PE Ziploop Extended ToggleLoc Sample
110005087S	ToggleLoc with ZipLoop Inline Sample

ACL Fixation – Fixed Loop

ToggleLoc Continuous Loop Femoral Fixation Device

Features

- Captures cortical bone of the femur
- Eliminates the need for a U-Guide

Material

- Titanium
- Polyethylene Suture

Indications

- Fixation of tendons and ligaments during orthopedic reconstruction procedures such as Anterior Cruciate Ligament (ACL) reconstruction.



ToggleLoc w/PE Continuous Loop Implants	
904720	15 mm
904721	20 mm
904722	25 mm
904723	30 mm
904724	35 mm
904725	40 mm
904726	45 mm
904727	50 mm

Educational Materials

Ref. Number	Description
BSM0019.2	ToggleLoc Continuous Loop Surgical Technique

Sample Products

Part Number	Description
904720D	ToggleLoc Demo Bone with Continuous Loop Sample

ACL Fixation – Devices

ToggleLoc XL with ZipLoop Technology

Features

- Indicated for primary ACL reconstruction and the unanticipated intra-operative cortical breaching cases
- Provides larger surface area for instances where larger tunnels are encountered
- Button is 20 mm, 7 mm longer than the standard ToggleLoc button



ToggleLoc Implants	
110005089	ToggleLoc XL with ZipLoop
110005090	ToggleLoc XL with ZipLoop Inline

Educational Materials

Ref. Number	Description
0270.1-US-en-REV0716	All Inclusive ACL Brochure
1683.1-GLBL-en	ToggleLoc and ToggleLoc XL ACL Reconstruction

Sample Products

Part Number	Description
110005089S	ToggleLoc XL with Ziploop Sample
110005090S	ToggleLoc XL Inline Sample

ACL Fixation – Instruments & Disposables

Instrumentation for the ToggleLoc with ZipLoop Technology



**Super MaxCutter™
Suture Cutter**
900342

Cannulated Bone Plug
110003541 5 Pack

**4.5 mm Calibrated
Spade Tip Guide Pin**
110007425 4.5 mm x 16"



4.5 mm Drill Bit
904760 **Disposable**
904765 **Reusable**



ToggleLoc Depth Gauge
904766



ZipLoop Puller
904776 **Reusable**
904794 **Disposable**

**ToggleLoc WasherLoc
Disposable Kit**

909846
Includes:
2.4 mm x 13" Drill Point K-Wire
2.4 mm x 16" Graft Passing Pin
ToggleLoc 4.5 mm Drill Bit
2.4 mm x 10" Drill Point K-Wire
3.2 mm Drill Bit
ACL Bone Plug

**ToggleLoc with ZipLoop
Implant Kit**

909848
Includes:
3.2 mm x 5" Solid Drill Bit
ToggleLoc Device w/ ZipLoop
Technology
4.5 mm ToggleLoc Drill Bit
1.1 mm x 14" Nitinol Guide Wire
3/32" Femoral Aimer Guide Pin
3/32" Modular Guide Pin

BTB Implant Kit

909849
Includes:
3.2 mm x 5" Solid Drill Bit
ToggleLoc Device w/ ZipLoop
Technology w/ Continuous Loop
for BTB
4.5 mm ToggleLoc Drill Bit
1.1 mm x 14" Nitinol Guide Wire
3/32" Femoral Aimer Guide Pin
3/32" Modular Guide Pin

ACL Disposable Kit

110004136
Includes:
Cannulated Bone Plug
1.1 Calibrated Nitinol Guide Wire
Calibrated 3/32" x 16" Trocar Tip
Femoral Guide Pin
Graft Protector
2.4 mm Drill Point K-Wire

**ToggleLoc Inline Implant
Kit**

110007421
Includes:
3.2 mm Drill Bit
4.5 mm ToggleLoc Drill
2.4 mm K-Wire
Cannulated Bone Plug
3/32" x 18" Trocar Tip Pin
Graft Protector
1.1 mm Nitinol Guide Wire
ToggleLoc Inline Implant

ACL Fixation – Implants

ComposiTCP™ 60 Interference Screws

Features

- ComposiTCP 60, made with a composite blend of 40% PLDLA and 60% beta Tri-Calcium Phosphate (designed for soft-tissue fixation)
- Available in both fully threaded and round head sizing options
- All screw sizes compatible with 1.1 mm guide wire



ComposiTCP 60 Interference Screws	
905256	9 x25 mm, Round Head
905257	9 x30 mm, Round Head
905258	9 x 35 mm, Round Head
905261	10 x 30 mm, Fully Threaded
905262	10 x 35 mm, Fully Threaded
905263	11 x 30 mm, Fully Threaded
905264	11 x 35 mm, Fully Threaded

Educational Materials

Ref. Number	Description
0405.2-GLBL-en-REV0317	ACL Reconstruction – Medial Portal
0270.1-US-en-REV0716	All Inclusive ACL Brochure
2057.1-GLBL-en-REV0818	ComposiTCP Interference Screw Sales Sheet

ACL Fixation – Implants

ComposiTCP 30 Interference Screws

Features

- ComposiTCP 30, made with a composite blend of 70% PLDLA and 30% beta Tri-Calcium Phosphate (designed for ACL fixation)
- Available in both fully threaded and round head sizing options
- All screw sizes compatible with 1.1 mm guide wire

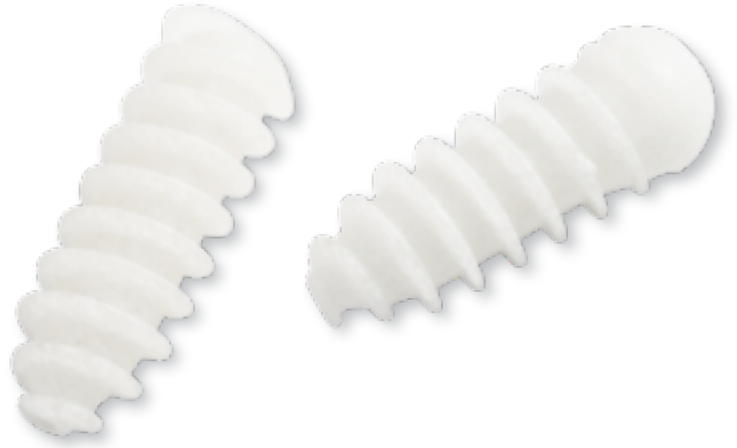

ComposiTCP 30 Interference Screws	
110004604	7 x 20 mm, Round Head
110004605	7 x 25 mm, Round Head
110004608	8 x 20 mm, Round Head
110004609	8 x 25 mm, Round Head
110004611	8 x 30 mm, Round Head
905216	9 x 25 mm, Round Head
905217	9 x 30 mm, Round Head
110004594	7 x 25 mm, Full Threaded
110004595	7 x 25 mm, Full Threaded
110004598	8 x 20 mm, Full Threaded
110004599	8 x 25 mm, Full Threaded
110004612	9 x 25 mm, Full Threaded

Educational Materials

Ref. Number	Description
0270.1-US-en-REV0716	All Inclusive ACL Brochure
2057.1-GLBL-en-REV0818	ComposiTCP Interference Screw Sales Sheet

ACL Fixation – Instruments

Instrumentation for the CompositCP Interference Screws

CompositCP 60 Driver

905272 9-11 mm

CompositCP Modular Driver

905273 7-8 mm

905274 9-11 mm

CompositCP Modular Tap

905278 9-11 mm



Universal Ratchet Handle

909733



Nitinol Guide Wire, Non-Sterile

906849 1.1 mm x 14"

906850 1.5 mm x 14"

906852 1.1 mm x 9"

906853 1.5 mm x 9"

906854 2.0 mm x 9"

CompositCP 1.1 Modular Driver

110004607 7-8 mm

CompositCP 1.1 Tap

110004597 7-8 mm

ACL Fixation – Implants

Titanium Interference Screws

Features

- Round head designed to minimize the possibility of graft damage during or after graft implantation
- Standard 2.5 mm and 3.5 mm hex for easier insertion and removal
- Cannulated for use with a guide wire
- Tapered tip for easier starts and straighter tracking

Material

- Titanium Alloy



Round Head Interference Screws	
909652	6 x 25 mm
909658	7 x 20 mm
909660	7 x 25 mm
909662	7 x 30 mm
909666	8 x 20 mm
909668	8 x 25 mm
909670	8 x 30 mm
909674	9 x 20 mm
909677	9 x 25 mm
909680	9 x 30 mm
909686	10 x 20 mm
909689	10 x 25 mm

Fully Threaded Interference Screws	
909659	7 x 20 mm
909661	7 x 25 mm
909663	7 x 30 mm
909667	8 x 20 mm
909669	8 x 25 mm
909671	8 x 30 mm
909675	9 x 20 mm
909679	9 x 25 mm
909681	9 x 30 mm

Educational Materials

Ref. Number	Description
0270.1-US-en-REV0716	All Inclusive ACL Brochure

Sample Products

Part Number	Description
909674S	9 x 20 mm Round Head Interference Screw Sample

ACL Fixation – Instruments

Instrumentation for the Titanium Interference Screws



**3.5mm Cannulated
Screwdriver**

906846



**ACL Revision Hex Bit
Cannulated**

909730 **3.5 mm**
909731 **2.5 mm**



Nitinol Guide Wire

906851 **2.0 mm x 14"**
906852 **1.1 mm x 9"**
906853 **1.5 mm x 9"**
906854 **2.0 mm x 9"**



Drill Bit

908406 **2.0 mm x 5"**

ACL Fixation – Tibial Fixation

WasherLoc Tibial Fixation

Features

- Bi-cortical fixation with either cortical or cancellous screws
- Countersunk to remove hardware prominence that can cause patient discomfort
- Distal fixation allows circumferential healing of graft to the tunnel wall
- Strength: 905 N¹
- Stiffness: 273 N/mm¹

Material

- Titanium alloy



WasherLoc Cortical Screw	
908630	30 mm
908632	32 mm
908634	34 mm
908636	36 mm
908638	38 mm
908640	40 mm
908642	42 mm
908644	44 mm
908646	46 mm
908648	48 mm
908650	50 mm
908652	52 mm
908654	54 mm
908656	56 mm
908658	58 mm
908660	60 mm

WasherLoc Cancellous Screw	
908824	24 mm 6 mm
908826	26 mm 6 mm
908828	28 mm 6 mm
908830	30 mm 6 mm
908832	32 mm 6 mm
908834	34 mm 6 mm
908836	36 mm 6 mm
908838	38 mm 6 mm
908840	40 mm 6 mm
908842	42 mm 6 mm
908844	44 mm 6 mm
908846	46 mm 6 mm
908848	48 mm 6 mm
908850	50 mm 6 mm
908852	52 mm 6 mm
908854	54 mm 6 mm
908856	56 mm 6 mm
908858	58 mm 6 mm
908860	60 mm 6 mm

WasherLoc Tissue Fixation	
908434	14 mm Short
908436	16 mm Short
908438	18 mm Short
908469	16 mm with 4 Extended Spikes
908468	18mm with 4 Extended Spikes

Educational Materials

Ref. Number	Description
0383.1-GLBL-en-REV0516	Transtibial Surgical Technique for Placement of the Femoral Tunnel in the I.D.E.A.L. Position
0270.1-US-en-REV0716	All Inclusive ACL Brochure

Sample Products

Part Number	Description
908436S	16 mm WasherLoc Tissue Fixation Sample
908632S	WasherLoc Screw Sample

1. Magen HE, Howell SM, Hull ML: "Structural properties of six tibial fixation methods for anterior cruciate ligament soft-tissue grafts." American Journal of Sports Medicine, 27:35-43, 1999.

ACL Fixation – Instrumentation/Disposables

Instrumentation for the WasherLoc Tibial Fixation

 Drill Bit 904301 3.2 mm	 Awl Guide 908426	 Drill Guide/Inserter 908437	 Easy-Out Screw Extractor 909734 2.5 mm
 Hex Screwdriver 904307 3.5 mm	 Countersink 908427	 Awl 908439	 ACL Revision Hex Bit Non-Cannulated 909741 3.5 mm
 No-Profile Countersink 904308	 Depth Gauge 908433	 Remover 908440	Guide Wire 909838 3/32" x 13" (25 Pack) Guide Pin Fr Femoral Aimer 909839 3/32" x 16" (25 Pack)
ACL Guide Wire Disposable Kit 907871 <i>Includes:</i> 1.1 mm Nitinol Guide Wire (14") 1.5 mm Nitinol Guide Wire (14") 3/32" Guide Wire (13") 3/32" Femoral Aimer Guide Pin (16")		Double Tunnel Tibial Guide 909513 Double Tunnel Tibial Guide Bullet 909514	Guide Wire 945019 1.1 mm x 6" 945020 1.6 mm x 6" K-Wire Dia/Rnd Chk 951578 .06 mm x 9"

ACL Fixation – Implants

TunneLoc Tibial Fixation System

Features

- Hands-free tensioner removes creep from the system and maintains tension during implant insertion
- Graft tensioner and inserter shaft eliminate the need for reusable instruments, saving costly preparation time
- PEEK-OPTIMA® implant affixes the soft tissue graft in the tibial tunnel with one simple surgical step
- Size of implants range from 8 to 11 mm

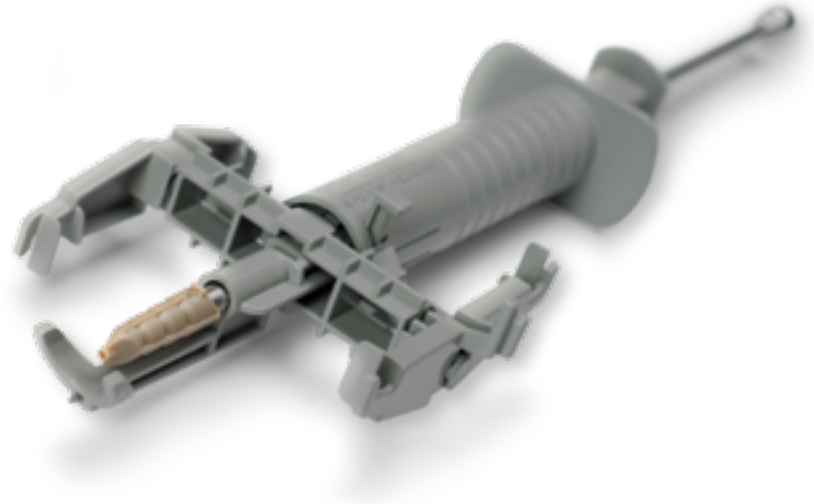

TunneLoc Tibial Fixation	
906512	8 mm
906513	9 mm
906514	10 mm
906515	11 mm

Educational Materials

Ref. Number	Description
0387.1-GLBL-en-REV0416	Tibial Fixation
0270.1-US-en-REV0716	All Inclusive ACL Brochure
0385.1-GLBL-en	ToggleLoc Inline Fixation Device with TunneLoc Tibial Fixation System Surgical Technique

Sample Products

Part Number	Description
906512S	8 mm TunneLoc Implant Sample
906514S	10 mm TunneLoc Implant Sample
906515S	11 mm TunneLoc Implant Sample

ACL Fixation – Implants

No-Profile Screws

Features

- 14, 18 and 20 mm washers maximize soft tissue fixation
- Cruciate screwdriver to reduce stripping that results from high torque used in insertion and screw removal
- Tapping and self-tapping screws available in 30 to 60 mm in 2 mm increments

Material

- Titanium alloy

Indications

- Intended for soft tissue fixation to bone, specifically during ligament reconstructive procedures



No-Profile Screw and Washer	
904414	14 mm Tissue Washer
904418	18 mm Tissue Washer
904420	20 mm Tissue Washer
904428	18 mm Flat Washer

No-Profile 6.5 mm Cancellous Screw	
904530	30 mm
904535	35 mm
904540	40 mm
904545	45 mm
904550	50 mm
904555	55 mm
904560	60 mm
904565	65 mm
904570	70 mm

No Profile Selftap Bicortical Screw	
904630	30 mm
904632	32 mm
904634	34 mm
904636	36 mm
904638	38 mm
904640	40 mm
904642	42 mm
904644	44 mm
904646	46 mm
904648	48 mm

ACL Fixation – Implants

Poly Suture Button

Features

- Solid fixation for either primary or auxiliary fixation in ACL or PCL reconstruction
- Distal fixation allows circumferential healing of the ACL graft to the tunnel wall

Material

- UHMWPE



ACL Suture Button	
904215	15 mm
904219	19 mm

ACL Fixation – Implants

AperFix II Femoral Implants

Features

- Circumferential graft compression gives tendon-to-bone contact
- Fixation at the native footprint
- No special instrumentation or kits required
- Aperture compression shortens construct to minimize graft motion

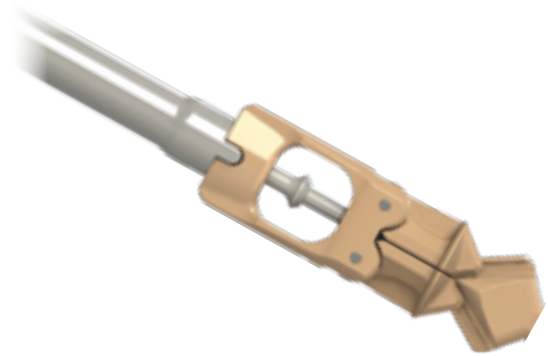

AperFix II Femoral Implant with Inserter	
CM-2909	9 mm x 29 mm
CM-2910	10 mm x 29 mm
CM-2911	11 mm x 29 mm

Educational Materials

Ref. Number	Description
1477.1-GLBL-en	The AperFix System – The Anatomic Implant AM Portal Surgical Technique Guide
1486.1-GLBL-en	The AperFix System

ACL Fixation – Implants

AperFix AM Femoral Implants

Features

- Active Circumferential Graft Compression from the joint space to the cortex
- Anatomic Reconstruction of the Native Tibial Footprint
- The all PEEK-OPTIMA AperFix II Cannulated Tibial System allows for anatomic positioning of the tibial graft and delivers strong, rigid fixation¹

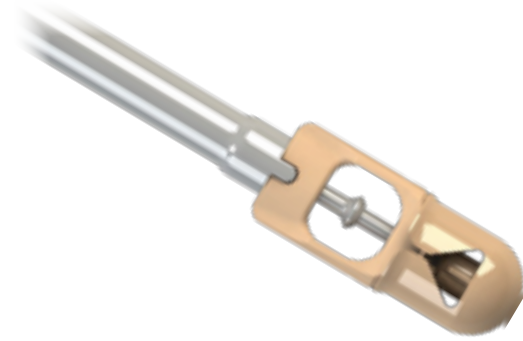

AperFix AM Femoral Implant with Inserter	
CM-2409	9 mm x 24 mm
CM-2410	10 mm x 24 mm

Educational Materials

Ref. Number	Description
1477.1-GLBL-en	The AperFix System – The Anatomic Implant AM Portal Surgical Technique Guide
1486.1-GLBL-en	The AperFix System

1. Uribe JW, Arango D, Frank J, Kiebzak GM. Two-year Outcome With the AperFix System for ACL Reconstruction. Orthopedics. 2013; 36(2): 159-164.

ACL Fixation – Implants

AperFix II Tibial Implants

Features

- Active Circumferential Graft Compression from the joint space to the cortex
- Anatomic Reconstruction of the Native Tibial Footprint
- The all PEEK-OPTIMA AperFix II Cannulated Tibial System allows for precise anatomic positioning of the tibial graft and delivers strong, rigid fixation¹

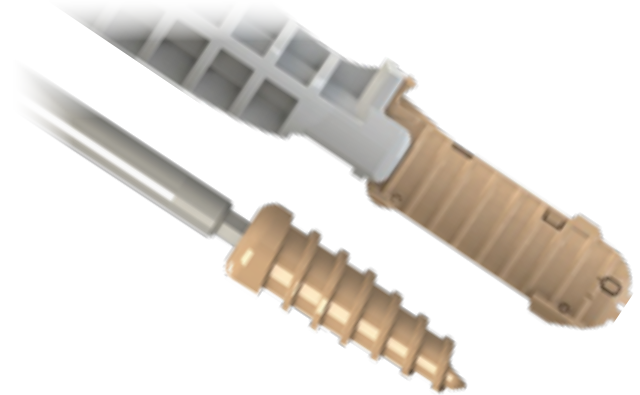

AperFix Tibial Implant with Driver	
CM-3008	8 mm x 30 mm
CM-3009C	9 mm x 30 mm Cannulated
CM-3010C	10 mm x 30 mm Cannulated
CM-3011C	11 mm x 30 mm Cannulated

Educational Materials

Ref. Number	Description
1486.1-GLBL-en	The AperFix System
1474.1-GLBL-en	The AperFix System – The Anatomic Implant Transtibial Surgical Technique Guide
1477.1-GLBL-en	The AperFix System – The Anatomic Implant AM Portal Surgical Technique Guide
1471.1-GLBL-en	The AperFix System – The Anatomic Implant Removal Technique Guide
1476.1-GLBL-en	The AperFix System – The Anatomic Implant PCL Surgical Technique Guide

1. Uribe JW, Arango D, Frank J, Kiezbak GM. Two-year Outcome With the AperFix System for ACL Reconstruction. Orthopedics. 2013; 36(2): 159-164.

ACL Fixation – Disposables & Instruments

Instrumentation for the ACL Disposable Kits & Instruments



ACL Disposable Procedure Kit

CM-1501 **Sterile**

Includes:

- 2.4 mm Drill Tip Guide Wire
- 2.4 mm Passing Pin
- 1.1 mm Nitinol Guide Wire
- 2.0 mm Nitinol Guide Wire
- Tibial Cannula



Guide Wire

CM-7014 **2.4 mm x 14" Sterile**



Removal Coring Reamer

CM-7109ST **9 mm, Sterile**
 CM-7110ST **10 mm, Sterile**
 CM-7111ST **11 mm, Sterile**



Low Profile Drill & EZ Shuttle® Suture Loop

CM-7609 **9 mm, Sterile**
 CM-7610 **10 mm, Sterile**
 CM-7611 **11 mm, Sterile**

ACL Fixation – Implants

iFix Interference Screws

Features

- Strong, rigid fixation
- No tapping required facilitated by strong, uniquely angled tip that saves procedural time
- Radiolucent for exceptional imaging clarity compared to metallic screws
- Bio-Inert properties minimize inflammatory responses common to absorbable polymers.
- Easily revised through removal or over - drilling



iFix Interference Screw	
CM-1720	7 mm x 20 mm
CM-1725	7 mm x 25 mm
CM-1820	8 mm x 20 mm
CM-1825	8 mm x 25 mm
CM-1830	8 mm x 30 mm
CM-1920	9 mm x 20 mm
CM-1925	9 mm x 25 mm
CM-1930	9 mm x 30 mm
CM-1025	10 mm x 25 mm
CM-1030	10 mm x 30 mm
CM-1130	11 mm x 30 mm
CM-1230	12 mm x 30 mm

iFix Driver	
CM-1245	2.45 mm
CM-1345	3.45 mm

Educational Materials

Ref. Number	Description
2029.1-GLBL-en	The iFix System Surgical Technique
20330 Rev. A	iFix System Surgical Technique Guide for Reps
20331 Rev. A	iFix System White Paper Cyclic Testing

ACL Fixation – Implants

AFX Femoral Implant

Features

- True Aperture Fixation
- Rigid mechanical fixation with 360° intra-tunnel active fixation
- Simple, reproducible, and quick technique with open eyelet for simple graft loading



AFX Femoral Implant with Inserter	
CM-2509AFX	9 mm x 25 mm
CM-2510AFX	10 mm x 25 mm

Educational Materials

Ref. Number	Description
1484.1-GLBL-en-REV0618	AFX Femoral Implant with AperFix Tibia System – AM Portal Surgical Technique

Meniscus Repair

Implants

JuggerStitch Meniscal Repair Device

Features

- Ergonomic delivery mechanism that allows for quick and simple implant deployment
- The low profile taper tip needle intended to minimize cutting the meniscal tissue during insertion
- The all suture knotless implant allows for controlled tensioning while eliminating rigid plastic anchors and hard meniscal surface knots



MENISCUS

JuggerStitch Meniscal Device Implants & Instruments

110024772	Straight Implant
110024773	Curved Implant

Educational Materials

Ref. Number	Description
0031.2-GLBL-en	JuggerStitch Meniscal Repair Device Surgical Technique
1081.1-GLBL-en	JuggerStitch Meniscal Repair Device Selling Guide
1118.1-GLBL-en	JuggerStitch Meniscal Repair Device White Paper

Sample Products

Part Number	Description
110024772S	JuggerStitch Straight Sample
110024773S	JuggerStitch Curved Sample

Meniscus Repair – Disposables

Disposables for the JuggersStitch Meniscal Repair Device



Halfpipe Cannula

110027358



Suture Cutter

110031907

Meniscus Repair – CrossFix

CrossFix II System

Features

- Curved and straight delivery needles allow for access to multiple tear sites
- Sharp, stiff needles designed to maximize delivery and performance
- Incorporated depth limiter controls needle penetration



MENISCUS

CrossFix II System	
CM-8000	Disposable Procedure Kit Sled, Probe, and Suture Cutter
CM-8001	Meniscal Repair Device, Straight
CM-8002	Meniscal Repair Device, Up Curve

Educational Materials

Ref. Number	Description
60331 Rev C	The CrossFix II System All-Suture, All-Inside Meniscal Repair
60284 Rev C	CrossFix II – All-Suture, All-Inside Meniscal Repair System Surgical Technique Guide

Hip Arthroscopy Systems

Soft Anchor Systems

JuggerKnot Long Soft Anchor – 1.45 mm

Features

- Most commonly utilized for soft tissue to bone fixation in the hip
- Designed with a #6 polyester sleeve, loaded with either a #1 (blue/white) or #2 (blue) MaxBraid suture, and a 1.45 mm anchor
- Inserter is 2.3 inches longer than the original 1.4 mm anchor to provide sufficient amount of reach in all areas of the hip labrum
- 49 lbs. anchor pullout strength with #1 and 70 lbs. anchor pullout strength with #2 suture¹



JuggerKnot Long Soft Anchors	
916030	1.45 mm, (1) #1 MaxBraid Blue/White
010000324	1.45 mm, (1) #2 MaxBraid Blue
010000334	1.45 mm, (1) #1 MB Blue/White (10 Pack)
010000335	1.45 mm, (1) #2 MB Blue (10 Pack)

Educational Materials

Ref. Number	Description
0380.1-GLBL-en-REV0816	Hip Acetabular Labral Repair with the JuggerKnot Long Soft Anchor
0381.1-GLBL-en-REV0516	Hip Arthroscopy All Inclusive Brochure
0393.1-GLBL-en-REV0416	JuggerKnot and JuggerKnotless Soft Anchor All Inclusive Brochure

Sample Products

Part Number	Description
916030S	JuggerKnot Long, #1 MaxBraid Implant Sample
110002758	JuggerKnot Long, #1 MaxBraid Sample Reload (5 Pack)
110002756	JuggerKnot Long, #2 MaxBraid Implant Sample
110002757	JuggerKnot Long, #2 MaxBraid Sample Reload (5 Pack)

1. Data on file at Biomet Sports Medicine. Test Reports, AT47B, AT47D, BSM4, BSM03. Bench test results are not necessarily indicative of clinical results.

Hip System – Soft Anchor Systems

JuggerKnot Long Soft Anchor Instrumentation – 1.45 mm

1.45 mm Long Disposable Instrumentation

Part Number	Description	Components
916040	Disposable Straight Kit	Guide & Drill Bit
916020	Disposable Curved Kit	Curved Guide, Flex Drill Bit, Centering Sleeve
110016992	Centering Sleeve Kit	Centering Sleeve & Drill Bit
916036	Flexible Drill Bit	
916037	Rigid Drill Bit	



Straight Guide



Curved Guide

1.45 mm Reusable Instrumentation

Part Number	Description
110002759	Straight Fishmouth Guide
916034	Curved Guide
916035	Straight Four Pronged Guide
916038	Trocar
916039	Obturator



Reusable Straight Fishmouth Guide

1.45 mm JuggerKnot Long Sample Instrumentation

Part Number	Description	Components
916040S	Instrument Kit	Straight Guide, Curved Guide, Rigid Drill, Flex Drill, Centering Sleeve
916020S	Curved Kit Sample	Curved Guide, Flex Drill, Centering Sleeve



Flexible Drill Bit



Rigid Drill Bit

Hip System – Soft Anchor Systems

SureLock All-Suture Anchor – 1.4 mm

Features

- Inserter controlled deployment method for consistent anchor delivery
- Smaller anchor requires less bone removal than larger, hard anchors, leading to bone preservation and greater tissue-to-bone contact
- Curved guide allows closer anchor placement to the labrocartilage junction and "in-rim" positions further inferior and superior compared to larger anchors with straight instrumentation



SureLock All-Suture Anchor

CM-9614F	1.4 mm, (1) #2 Suture
----------	-----------------------

Instruments

CM-9640	Drill Bit, Disposable
CM-9640S	Drill with Centering Sleeve, Disposable
CM-9641	1.4 mm Obturator, Reusable
CM-9643	Straight Drill Guide, Reusable
CM-9645	Curved Drill Guide, Reusable

Educational Materials

Ref. Number	Description
80132 Rev B	SureLock All Suture Anchor System Surgical Technique Guide for Bankart Repair
80405 Rev B	SureLock All Suture Anchor System
70810 Rev A	Complete Shoulder Solutions

Sample Products

Part Number	Description
MK8021401	1.4 mm Suture Anchor Sample

Hip System – Suture Anchor Systems

Quattro GL/GL2 Suture Anchors – 2.9 mm

Features

- PEEK push-in anchor with a straightforward implantation technique. Indicated for shoulder and hip labral repair
- Single or double loaded anchors loaded with #2 Suture
- Individual suture eyelets allow sutures to freely slide



Quattro GL/GL2 Suture Anchors	
CM-9329	2.9 mm, (1) #2 Suture
CM-9329GL2	2.9 mm, (2) #2 Sutures

Instruments	
CM-9300ST	Drill Bit, Disposable
CM-9301	Drill Guide, Reusable
CM-9302	Obturator
CM-9303	Offset Drill Guide, Reusable
CM-9324ST	Hard Bone Drill, Disposable

Educational Materials

Ref. Number	Description
34049 Rev C	Quattro Shoulder System Innovative Labral Repair System
70331 Rev A	White Paper – Biomechanical Pullout Strength of Quattro GL Glenoid Labrum Repair Anchors
70827 Rev A	Solutions for Foot and Ankle Repair and Reconstruction

Sample Products

Part Number	Description
MK3400003	2.9 mm Suture Loaded Anchor with Inserter Sample

Hip System – Suture Passing System

SpeedSnare Suture Passer System

Features

- 1.8 mm tip designed to minimize tissue damage during tissue penetration without compromising the strength of the device
- The first system designed with “suture locked” and “suture sliding” positions with right and left bends
- Accepts suture and suture tape

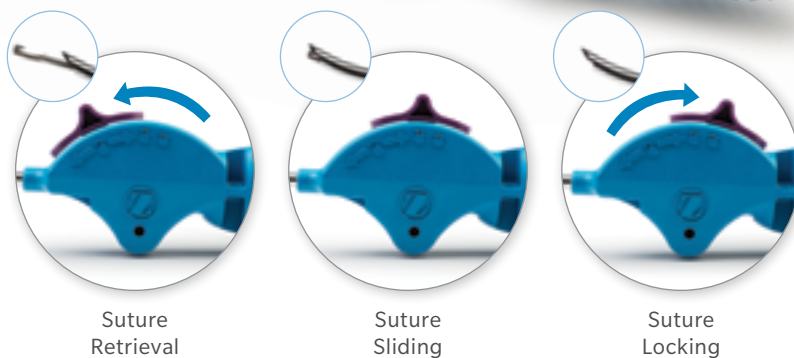

SpeedSnare Suture Passers	
110030129	30° Up (Purple)
110030130	60° Up (Black)
110030131	30° Right (Yellow)
110030132	30° Left (Red)
110030133	Straight (White)

Educational Materials

Ref. Number	Description
1460.1-US-en	Upper Extremities Instrumentation Brochure
1414.1-GLBL-en	SpeedSnare Suture Passer Flyer

Hip System – Suture Anchor Systems

Dragon Tongue Suture Passer

Features

- Extended Delivery
 - Adjustable slide delivers 30 mm of suture, creating an easily graspable suture loop
 - Designed for single portal capsular repair and is not dependent on angle of approach
- Range of Reach
 - Easily captures the delivered suture loop
 - Nitinol grasper can open and close along its 17 mm of extension beyond the needle shaft
- Variable Angles
 - Nitinol grasper advances out of the needle shaft at 60° and continues to extend further to a 70° bend
- Capture with Precision
 - The Dragon Tongue grasper’s active grasping design assists with accuracy in suture grasping
 - The PEEK tubing extends over the nitinol grasper to close the nitinol over the suture for active grasping



110038984	Dragon Tongue Suture Passer
-----------	------------------------------------

Educational Materials

Ref. Number	Description
2729.1-GLBL-en	Hip Capsule Closure Surgical Technique
2788.1-GLBL-en	Dragon Tongue Suture Passer Product Brochure

Hip Systems – Joint Access

Hip Access Kits

Features

- Includes the essentials required to arthroscopically access the hip joint space
- Different kit configurations to accommodate capsule blade preferences or pricing considerations
- One piece capsule blade design may reduce risk of blade falling off into the joint space



Hip Access Disposables and Kits	
640410BSM	Hip Access Kit (2 Access Needles & 2 Nitinol Guide Wires)
640420BSM	Hip Access Kit with Curved Blade, Blunt Tip
640430BSM	Hip Access Kit with Straight One Sided Blade, Blunt Tip
640431BSM	Hip Access Kit with Curved Blade, Sharp Tip
641410BSM	Hip Access System (2 Access Needles, 2 Nitinol Guide Wires, 30 CC Syringe)
641420BSM	Hip Access System with Curved Blade, Blunt Tip
641430BSM	Hip Access System with Straight One Sided Blade, Blunt Tip
641431BSM	Hip Access System with Curved Blade, Sharp Tip
169420BSM	Curved Blade, Blunt Tip
169430BSM	Straight One Sided Blade, Blunt Tip
169431BSM	Curved Blade, Sharp Tip

Educational Materials

Ref. Number	Description
0381.1-GLBL-en-REV0516	Hip Arthroscopy All Inclusive Brochure



Curved Blunt



Curved Sharp



Straight Blunt

Hip System – Instrumentation Trays

Hip System Trays

Features

- The ability to mix and match certain instruments for specific procedures
- The bottom four caddies can be swapped out depending upon surgeon preference

Hip instrument caddy options include:

- Hand Instruments
- JuggerKnot Long
- Microfracture

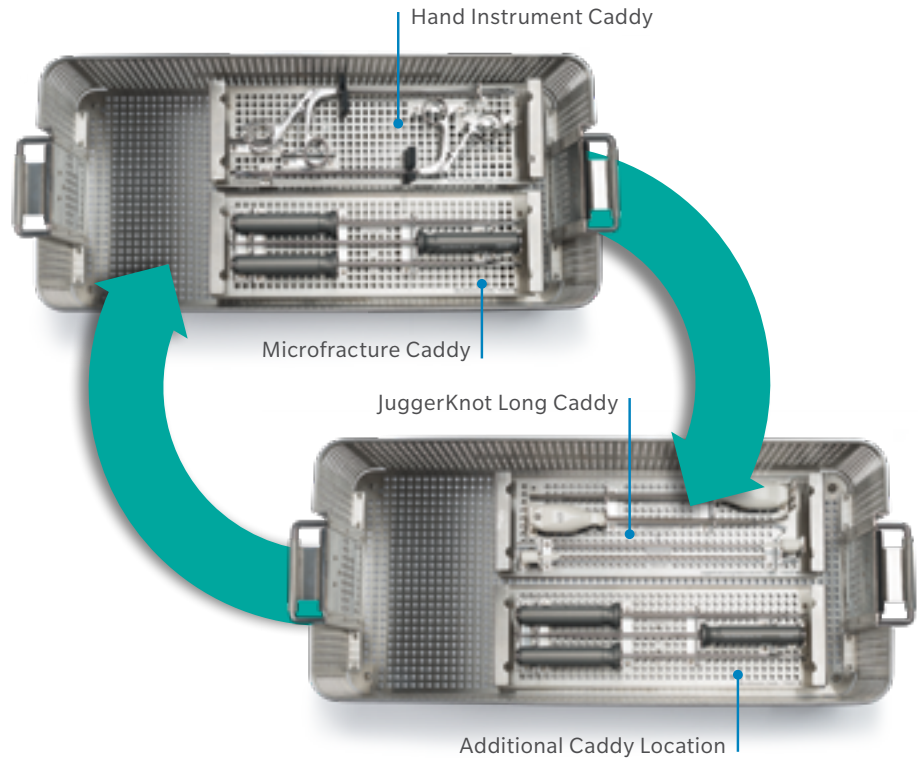

Hip System Trays	
110024748	Instrument Case
110024749	Instrument Lid
110024750	JuggerKnot Long Caddy
110024751	Hand Instrument Caddy
110024752	Microfracture Caddy

Educational Materials

Ref. Number	Description
0381.1-GLBL-en-REV0516	Hip Arthroscopy All Inclusive Brochure

Hip System – Hand Instrumentation

Hip Portal Management Instrumentation



Switch Stick

754420FBSM **4.0 mm**
 754440FBSM **4.5 mm**
 754450FBSM **5.0 mm**
 754480FBSM **5.5 mm**
 754470FBSM **6.0 mm**

Switch Stick Handle

754430FBSM



Probes

138405BSM **Straight Probe**
 138415BSM **Curved Probe**
 138416BSM **Angled Probe**



Slotted Cannula

754410BSM **6 mm**



HydroDam Cannulas

110019090 **8.5 x 100 mm**
 110019086 **8.5 x 115 mm**
 110030950 **8.5 x 130 mm**



HydroDam Reusable

110028430 **Handle**
 110028433 **Adjustable Shaft, 8.5 mm Diameter**

Hip Soft Tissue Management Instrumentation



Tissue Grasper

391400BSM **Straight 5 mm**
 391411BSM **20 Deg Right**
 391421BSM **20 Deg Left**
 397400BSM **Straight Grasper**



Biters

727400BSM **Straight 3 mm**
 727431BSM **15 Degree Up 3 mm**



Tissue Liberator

904131BSM **20 Deg**



Rasps

904431BSM **30 Deg Up**

Hip System – Instruments

Hip Suture Management Instrumentation



Hip Stitcher

328412BSM **Right**
328422BSM **Left**



Hip Suture Cutter

231400BSM
231410BSM **Short Tail**



Hip Knot Pusher

301400BSM



Hip Passer

399400BSM **Straight**
399431BSM **35 ° Up**



Hip Suture Manipulator

601400BSM



Hip Suture Grasper

602400BSM

Hip Cartilage Management Instrumentation



Curette

904441BSM **Bent**
20 Degree



Bone Spike

512404BSM **60 Degree**
512406BSM **40 Degree**
512400BSM **Straight**

Suture

Options

MaxBraid PE Suture

Features

- Braid structure is designed to allow the suture to lie flat for knot security.
- Silky smooth feel is gentle on tissue and gloves

Material

- Ultra High Molecular Weight Polyethylene (UHMWPE)

Indications

- For use in approximation and/or ligation of soft tissues, including use of allograft tissue for orthopedic surgeries

MaxBraid	
900244	Size #4-0 Blue/White Cobraid Suture with Tapered T-1 Needle (12 Pack)
900252	Size #3-0 Blue/White Cobraid Suture with Tapered T-2 Needle (12 Pack)
900267	Size #0 Blue/White Suture with Tapered T-2 Needle (12 Pack)
900284	Size #2 Blue/White Cobraid Suture with Cutting KHC-5 Needle (12 Pack)
900312	Size #5 White/Blue Suture with Cutting K-60 Needle (12 Pack)
900314	MaxBraid PE Suture Kit*
900333	Size #2 White Suture with Tapered HC-5 Needle (12 Pack)
900334	PE #2 Blue (12 Pack)
900335	Size #2 Blue/White Cobraid Suture with Tapered C-7 Needle (12 Pack)
900336	Size #2 Blue/White Cobraid Suture with Tapered AT-2 Needle (12 Pack)
900338	Size #2 Blue/White Cobraid Suture with Half Circle Tapered Needle (Single)



* MaxBraid PE Suture Kit Contains:

- (1) #2 MaxBraid Suture with Tapered Needle
- (1) #2 White MaxBraid Suture with Tapered Needle
- (1) #2 White/Blue MaxBraid Suture
- (1) #5 White MaxBraid Suture with Cutting Needle
- (1) #5 Blue MaxBraid Suture
- (4) #5 White/Blue MaxBraid Suture
- (1) #5 White MaxBraid Suture

Suture – Options

MaxBraid PE Suture (cont.)

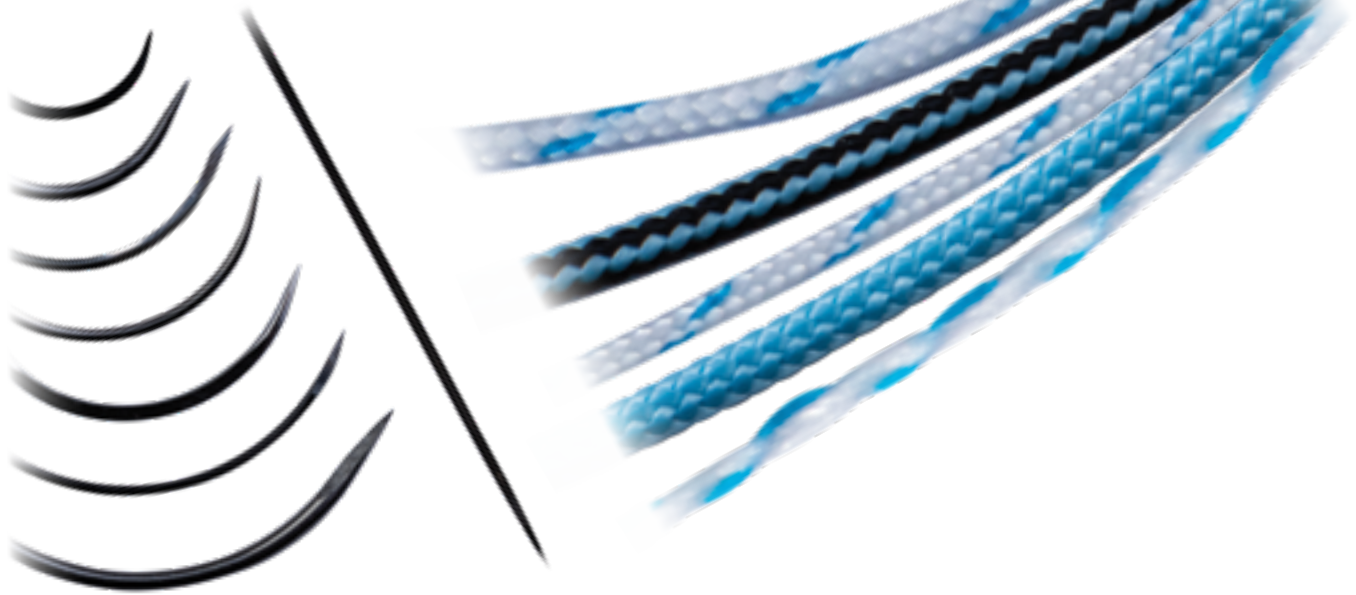

MaxBraid	
CM-0201	TRU-Link (Nonabsorbable) Size #2 Suture Blue Braided (12 Pack)
CM-0202	TRU-Link (Nonabsorbable) Size #2 Suture White/Blue Co-Braided (12 Pack)
CM-9500	Lock-Stitch Kit: (2) TRU-Loop Sutures, (1) Suture Needle
CM-0222	MaxBraid Suture 2 Pack: (1) Black/Blue #2 Suture (1) Blue #2 Suture
CM-0222N	MaxBraid Suture 2 Pack: (1) Black/Blue #2 Suture with Curved Taper Needle, (1) Blue #2 Suture with Curved Taper Needle
CM-0225N	MaxBraid Suture 2 Pack: (1) Black/Blue #5 Suture with Curved Taper Needle, (1) Blue #5 Suture with Curved Taper Needle
CM-0226N	MaxBraid Suture 2 Pack: (1) Black/Blue #5 Suture with Curved ConvCut Needle, (1) Blue #5 Suture with Curved ConvCut Taper Needle

Educational Materials

Ref. Number	Description
BSM0039.1	MaxBraid PE Suture Brochure
BSM0048.2	All Inclusive Shoulder Product Brochure
1325.1-GLBL-en	Suture Portfolio Brochure

Suture – Options

BroadBand Tape

Features

- Coreless, single braided tape construct
- Excellent pliability and handling characteristics
- Size #2 suture transitions into 1.5 mm tape
- Allows seamless loading into existing instrumentation (i.e. Suture Passers, knot pushers, suture cutters)
- Surgical knots can be tied

Material

- Ultra-High, Molecular Weight Polyethylene (UHMWPE) Tape



Educational Materials

Ref. Number	Description
1822.1-GLBL-en-REV0118	BroadBand Tape Flyer
1325.1-GLBL-en	Suture Portfolio Brochure

BroadBand Tape	
110030425	Size #2 Blue BroadBand Tape with Tapered Needles (12 Pack)
110030426	Size #2 White/Blue BroadBand Tape with Tapered Needles (12 Pack)
110030427	Size #2 White/Blue BroadBand Tape without Needles (12 Pack)
110030428	Size #2 Blue BroadBand Tape without Needles (12 Pack)
CM-0322	BroadBand Tape, 2 Pack: (1) Black/Blue Tape, 1.5 mm (1) Black Tape, 1.5 mm
CM-0321N	BroadBand Tape, 2 Pack: (1) Black/Blue Tape, 2.3 mm with Cutting Needles; (1) Black Tape, 2.3 mm with Cutting Needles
CM-0301	BroadBand Mini Loop: Blue 5" Tape Loop, 1.5 mm; 20" #2 Suture Tail
CM-0302	BroadBand Mini Loop: Black/Blue 5" Tape Loop, 1.5 mm; 20" #2 Suture Tail
CM-0303	BroadBand Mini Loop: Blue 3" Tape Loop, 1.5 mm; 27" Tape Tail, 1.5 mm
CM-0304	BroadBand Mini Loop: Black 3" Tape Loop, 1.5 mm; 27" Tape Tail, 1.5 mm

BroadBand Tape	
CM-0305CN	BroadBand Loop: Blue 25" Tape Loop, 1.5 mm; 1" #2 Suture Tail with Curved Taper Needle
CM-0305SN	BroadBand Loop: Blue 25" Tape Loop, 1.5 mm; 1" #2 Suture Tail with Straight Taper Needle
CM-0306CN	BroadBand Loop: Blue/Black 25" Tape Loop, 1.5 mm; 1" #2 Suture Tail with Curved Taper Needle
CM-0306SN	BroadBand Loop: Blue/Black 25" Tape Loop, 1.5 mm; 1" #2 Suture Tail with Straight Needle
CM-0323N	BroadBand Loop (2 Pack): (1) Black/Blue 23" Tape Loop, 2.3 mm, 1" #5 Suture Tail with Curved ConvCut Needle; (1) Blue 23" Tape Loop, 2.3 mm, 1" #5 Suture Tail with Curved ConvCut Needle
CM-0324N	BroadBand Loop (2 Pack): (1) White/Blue 23" Tape Loop, 2.3 mm, 1" #5 Suture Tail with Curved ConvCut Needle; (1) Black 23" Tape Loop, 2.3 mm, 1" #5 Suture Tail with Curved ConvCut Needle
CM-03017N	BroadBand Meniscal Needles: Blue 30" Tape, 1.0 mm to 2-0 Suture with Trocar Needles

Suture – Graft Preparation

ExpressBraid Graft Manipulation

Features

- Designed for efficient graft preparation using a #2 MaxBraid suture
- The design of the needle crimped to suture facilitates a smooth passage through the graft
- Stiff needle promotes easy handling
- Two colors (co-braid and white) for easy identification of grafts

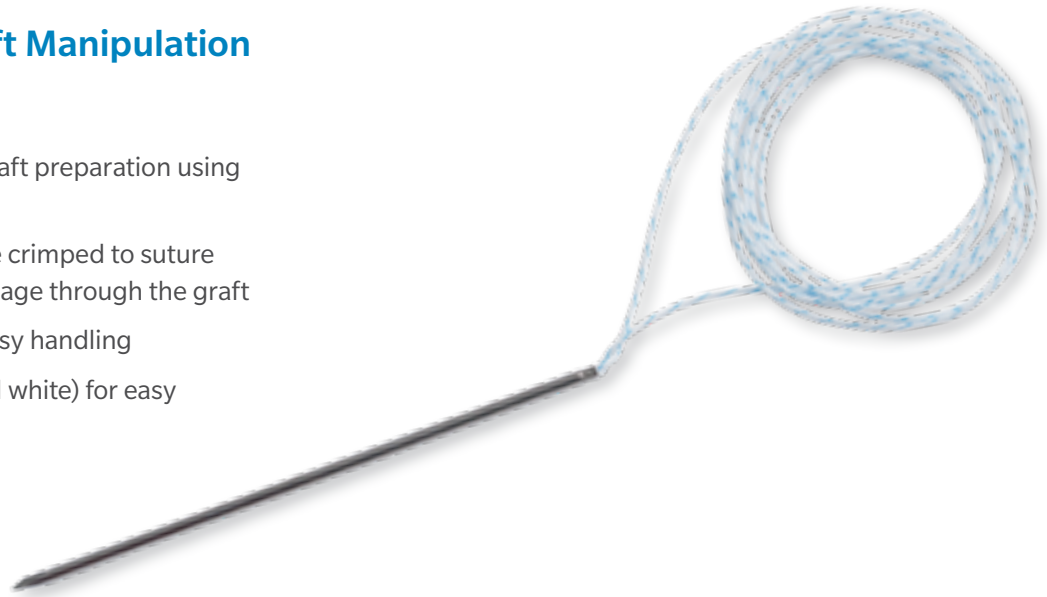

ExpressBraid	
110003540	Size #2 White (Single)
110003539	Size #2 Blue/White (Single)
110003538	Size #2 Blue/White (Single Sample)
110003463	Size #2 White (10 Pack)
110003464	Size #2 Blue/White (10 Pack)

Educational Materials

Ref. Number	Description
0270.1-US-en-REV0716	All Inclusive ACL Brochure
1325.1-GLBL-en	Suture Portfolio Brochure

Shoulder Rotator Cuff Repair

Ventix Link Knotless Anchors – 4.75 mm & 5.5 mm

Features

- Threaded, vented design allows for strong purchase in bone and potential bony integration
- Surgeon controlled tensioning after anchor insertion
- Multiple suture fixation points internally with cleat and externally with bone
- Accepts six suture limbs of MaxBraid Suture and BroadBand Suture Tape
- The eyelet cleat feature allows tension to be set, held, reversed (if necessary), and maintained during anchor deployment

Ventix Link Knotless Anchors	
110025990	4.75 mm
110025992	5.5 mm

Reusable Instruments	
110025999	Tapered Awl, 4.75/5.5 mm
110025998	Awl, 4.75/5.5 mm
110026000	Tap, 4.75 mm
110026001	Tap, 5.5 mm

Disposable Instruments	
110026002	Drill, 4.75 mm
110026003	Drill, 5.5 mm

Rotator Cuff Repair – Knotless Anchor Systems



Educational Materials

Ref. Number	Description
2021.3-US-en	Ventix Link Screw-In Knotless Anchor for Lateral Row Fixation in Rotator Cuff Repair Surgical Technique
1372.1-US-en	Ventix Link Implant Handout
2282.1-US-en	Ventix Link & Quattro X Implants Handout

Sample Products

Part Number	Description
MK7129901	4.75 mm Ventix Link Anchors ONLY (2-Pack)
MK7130001	4.75 mm Ventix Link Anchor with Inserter Sample

Rotator Cuff Repair – Knotless Anchor Systems

Quattro Link Knotless Anchors – 4.5 mm, 4.5 mm SP, & 5.5 mm

Features

- The eyelet cleat feature allows tension to be set, held, reversed (if necessary), and maintained during anchor deployment
- Internal cleat mechanism locks suture inside of the anchor during final deployment, in addition to interference fit with bone
- Indicated to accept up to 8 suture limbs or 6 tape limbs
- The 4.5 mm self-punching Quattro Link Knotless Anchor combines a titanium tip with a PEEK anchor body to allow for fast and efficient deployment



Quattro Link Knotless Anchors	
CM-9145	4.5 mm
CM-9145SP	4.5 mm, SP Metal Tip
CM-9155	5.5 mm

Reusable Instruments	
CM-9100	Awl, 4.5 mm & 5.5 mm
CM-9130	Drill, 4.5/5.5 mm
CM-9138	Hard Bone Drill, 4.5 mm
CM-9148	Hard Bone Drill, 5.5 mm

Sample Products

Part Number	Description
MK7007804	4.5 mm Quattro Link Anchor with Inserter Sample
MK70399	4.5 mm Quattro Link Anchor ONLY (2 Pack)
MK7007806	4.5 mm SP Quattro Link Anchor with Inserter Sample
MK70402	4.5 mm SP Quattro Link Anchor ONLY (2 Pack)
MK7007805	5.5 mm Quattro Link Anchor with Inserter Sample

Educational Materials

Ref. Number	Description
1479.1-US-en	Quattro Shoulder System Surgical Technique
70330 Rev A	White Paper – Biomechanical Pullout Strength Of Quattro X and Quattro Link Anchors
1530.1-GLBL-en	Complete Shoulder Solutions Flyer

Rotator Cuff Repair – Suture Anchor Systems

Quattro X Suture Anchors – 5.5 mm & 6.5 mm

Features

- Double loaded with BroadBand Tape or #2 suture. Triple loaded suture option also available
- Non-Sliding (Fixed) tape option for double row knotless repairs
- Sliding tape option for single or double row knotted repairs
- Blunt tip for easy insertion into pilot hole



Quattro X PEEK Suture Anchors with #2 Suture	
CM-9255	5.5mm, (2) #2 Sutures
CM-9255X3	5.5mm, (3) #2 Sutures
CM-9265	6.5mm, (2) #2 Sutures

Quattro X PEEK Suture Anchors with BroadBand Tape	
CM-9255BG	5.5 mm, Double Loaded with #2 BroadBand tape, (1) non-sliding (1) sliding
CM-9265BG	6.5 mm, Double Loaded with #2 BroadBand tape, (1) non-sliding (1) sliding
CM-9255BGS	5.5 mm, Double Loaded with #2 BroadBand tape, (2) sliding
CM-9265BGS	6.5 mm, Double Loaded with #2 BroadBand tape, (2) sliding

Reusable Instruments	
CM-9200	Awl, 5.5 mm & 6.5 mm
CM-9201	Tap, 5.5 mm
CM-9202	Tap, 6.5 mm
CM-9203	Tap, 5.5 mm

Educational Materials

Ref. Number	Description
1479.1-US-en	Quattro Shoulder System Surgical Technique
70330 Rev A	White Paper – Biomechanical Pullout Strength of Quattro X and Quattro Link Anchors
1530.1-GLBL-en	Complete Shoulder Solutions Flyer
0603.1-US-en	Quattro X Suture Anchor with BroadBand Tape Surgical Technique
2420.1-GLBL-en	Quattro X with BroadBand Tape Brochure
2282.1-US-en	Ventix Link & Quattro X Implants Handout

Sample Products

Part Number	Description
MK7002005	5.5 mm Quattro X Anchor with Inserter Sample
MK7002006	6.5 mm Quattro X Anchor with Inserter Sample
MK7128702	5.5 mm Quattro X Anchor with BroadBand Tape (Non-Sliding) Sample
MK7128701	5.5 mm Quattro X Anchor with BroadBand Tape (Sliding) Sample

Rotator Cuff Repair – Suture Anchor Systems

ComposiTCP Suture Anchors – 4.5 mm, 5.5 mm, 6.5 mm

Features

- Anchors made from Duosorb material, a synthetic biocomposite material composed of 30% β -TCP and 70% PLDLLA
- Double-Loaded with BroadBand Tape or #2 MaxBraid Suture
- Non-Sliding (Fixed) tape option for double row knotless repairs
- Sliding tape option for single or double row knotted repairs



ComposiTCP Biocomposite Suture Anchors with MaxBraid Suture

110026105	4.5 mm, (2) #2 MaxBraid Sutures
110026106	5.5 mm, (2) #2 MaxBraid Sutures
110026107	6.5 mm, (2) #2 MaxBraid Sutures

ComposiTCP Biocomposite Suture Anchors with BroadBand Tape

110026108	4.5mm, Double-Loaded with #2 BroadBand Tape, (2) sliding
110026109	5.5mm, Double-Loaded with #2 BroadBand Tape, (2) sliding
110026110	6.5mm, Double-Loaded with #2 BroadBand Tape, (2) sliding
110026113	4.5mm, Double-Loaded with #2 BroadBand Tape, (1) non-sliding (1) sliding
110026114	5.5mm, Double-Loaded with #2 BroadBand Tape, (1) non-sliding (1) sliding
110026115	6.5mm, Double-Loaded with #2 BroadBand Tape, (1) non-sliding (1) sliding

Reusable Instruments

110026111	Punch/Tap, 4.5 mm
110026112	Punch/Tap, 5.5/6.5 mm

Educational Materials

Ref. Number	Description
2193.1-GLBL-en	ComposiTCP Anchor with BroadBand Tape Surgical Technique
1874.2-US-en	ComposiTCP Suture Anchor with MaxBraid Suture Brochure
2648.1-US-en	ComposiTCP Anchor with Non-Sliding BroadBand Tape Surgical Technique
2658.1-GLBL-en	ComposiTCP Suture Anchor with BroadBand Tape Brochure

Sample Products

Part Number	Description
110026105S	4.5 mm ComposiTCP Anchor with #2 MaxBraid Suture Sample
110026106S	5.5 mm ComposiTCP Anchor with #2 MaxBraid Suture Sample
110026108S	4.5 mm ComposiTCP Anchor with BroadBand Tape (Sliding) Sample
110026109S	5.5 mm ComposiTCP Anchor with BroadBand Tape (Sliding) Sample
110026113S	4.5 mm ComposiTCP Anchor with BroadBand Tape (Non-Sliding) Sample
110026114S	5.5 mm ComposiTCP Anchor with BroadBand Tape (Non-Sliding) Sample
110026115S	6.5 mm ComposiTCP Anchor with BroadBand Tape (Non-Sliding) Sample

Rotator Cuff Repair – Suture Anchor Systems

ALLthread Suture Anchors – 5.0 mm, 5.5 mm, 6.5 mm, 6.8 mm

Features

- Fully-threaded to achieve cortical fixation
- Available with and without needles
- Available in PEEK and titanium materials

ALLthread PEEK Suture Anchors	
905942P	5.5 mm, (2) #2 MaxBraid, (1) White (1) Blue/White
904932P	5.5 mm, (2) #2 MaxBraid, (1) Green/White (1) Blue/White
904921P	5.5 mm, (3) #2 MaxBraid
904922P	5.5 mm, (3) #2 MaxBraid, Tapered Needles
905944P	6.8 mm, (2) #2 MaxBraid
904923P	6.8 mm, (3) #2 MaxBraid
904924P	6.8 mm, (3) #2 MaxBraid, Tapered Needles

ALLthread Titanium Suture Anchors	
902581	5.0 mm, (2) #2 MaxBraid, Tapered Needles
902582	6.5 mm, (2) #2 MaxBraid, Tapered Needles
902588	5.0 mm, (2) #2 MaxBraid, Cutting Needles
902589	6.5 mm, (2) #2 MaxBraid, Cutting Needles
902614	5.0 mm, (3) #2 MaxBraid, Tapered Needles
902615	6.5 mm, (3) #2 MaxBraid, Tapered Needles
902591	5.0 mm, (2) #2 MaxBraid, (1) White (1) Blue/White
902592	6.5 mm, (2) #2 MaxBraid, (1) White (1) Blue/White
902610	5.0 mm, (2) #2 MaxBraid, (1) Blue/White (1) Black/White
902611	6.5 mm, (2) #2 MaxBraid, (1) Blue/White (1) Black/White
902612	5.0 mm, (3) #2 MaxBraid, (1) Blue/White (1) White (1) Black/White
902613	6.5 mm, (3) #2 MaxBraid, (1) Blue/White (1) White (1) Black/White

Reusable Instruments	
905955	Punch, 5.5 mm/6.8 mm (PEEK)
905958	Tap, 5.5 mm (PEEK)
905959	Tap, 6.8 mm (PEEK)
905961	Drill, 5.0 mm (Titanium)



Educational Materials

Ref. Number	Description
0409.2-GLBL-en	Rotator Cuff Repair with ALLthread Suture Anchors Surgical Technique

Sample Products

Part Number	Description
905942PS	5.5 ALLthread PEEK (2) #2 MaxBraid Sample
905944PS	6.8 ALLthread PEEK (2) #2 MaxBraid Sample
902592S	6.5 ALLthread Ti (2) #2 MaxBraid Sample

Rotator Cuff Repair – Soft Anchor Systems

JuggerKnot Soft Anchors – 2.9 mm

Features

- Available with and without needles for arthroscopic and mini-open repairs
- Tapered and cutting needle options available
- Manual deployment method

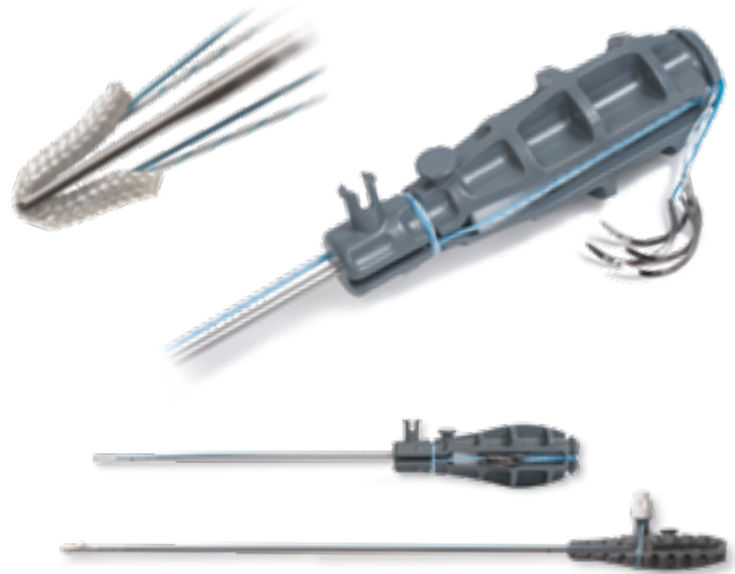

JuggerKnot Soft Anchors	
912029	2.9 mm, (2) #2 MaxBraid
912529	2.9 mm, (2) #2 MaxBraid (10 Pack)
110005093	2.9 mm Short, Cutting Needles
110005096	2.9 mm Short, Tapered Needles
110005241	2.9 mm Short, Cutting Needles (10 Pack)
110005242	2.9 mm Short, Tapered Needles (10 Pack)

JuggerKnot 2.9 mm Instruments	
912091	Drill Bit, Disposable
912057	Disposable Straight Kit (Guide, Drill)
912064	In Guide Punch, Reusable
912090G	Straight Guide, Reusable
912092G	Obturator, Reusable
912093G	Trocar, Reusable

JuggerKnot 2.9 mm Short & 2.9 mm Short with Needles Instruments	
110005306	Drill Bit, Disposable
912059	Punch, Reusable
110016951	Straight Guide, Reusable

Educational Materials

Ref. Number	Description
0395.1-GLBL-en-REV0916	Arthroscopic and Mini-Open Rotator Cuff Repair with JuggerKnot Soft Anchor – 2.9 mm Surgical Technique
0393.1-GLBL-en-REV0416	JuggerKnot and JuggerKnotless Soft Anchor – All-Inclusive Brochure
0391.1-GLBL-en-REV0416	JuggerKnot Soft Anchor – FAQ
0410.1-GLBL-en-REV0516	JuggerKnot Soft Anchor – 2.9 mm with Needles Flyer
0763.1-US-en REV0117	Soft Anchor Selling Guide

Sample Products

Part Number	Description
912029S	2.9 mm JuggerKnot Blue Sample
912029SR	2.9 mm JuggerKnot Blue Sample Reload (5 Pack)
912050S	2.9 mm JuggerKnot Sample
912050SR	2.9 mm JuggerKnot Sample Reload (5 Pack)
110005243	2.9 mm JuggerKnot Cutting Needles Sample
110005244	2.9 mm JuggerKnot Tapered Needles Sample

Rotator Cuff Repair – Soft Anchor Systems

SureLock All-Suture Anchors – 2.2 mm

Features

- Inserter-controlled deployment method provides consistent anchor delivery beneath the cortex
- Single and double loaded anchors (1.4 mm single loaded anchor, 2.2 mm double loaded anchor) have pull-out strength comparable to hard anchors¹
- Small profile anchors compared to hard anchors allows for small pilot hole footprint and minimal bone removal
- Complete instrumentation - Straight and 25° curvature drill guides allow perpendicular bone drilling at anchor site with center-sleeved drill



SureLock All-Suture Anchors	
CM-9622F	2.2 mm, (2) # 2 Sutures

Disposable Instruments	
CM-9620	Drill Bit, Disposable
CM-9620S	2.2 mm Drill Bit with Centering Sleeve, Disposable

Reusable Instruments	
CM-9621	Obturator, Reusable
CM-9623	Straight Drill Guide, Reusable
CM-9625	Curved Drill Guide, Reusable

Educational Materials

Ref. Number	Description
1453.1-GLBL-en	SureLock All-Suture Anchor System Surgical Technique for Bankart Repair
1454.1-GLBL-en	SureLock All-Suture Anchor System Brochure
1530.1-GLBL-en	Complete Shoulder Solutions Flyer
0763.1-US-en	Soft Anchor Selling Guide

1. Data on file Report 80070; 092013. Bench test results are not necessarily indicative of clinical results.

Rotator Cuff Repair – BioWick Implant Systems

BioWick Implants – 2.7 mm, 5.5 mm, 6.5 mm

Features

- Interpositional Scaffold: Designed to address the biological issues of RCR
- All-In-One Scaffold Wick + Suture Anchor Design: Utilizes the same technique as a standard medial row suture anchor
- Aligned PLGA Fibers: Designed to mimic the Extra Cellular Matrix of the native rotator cuff tendon
- PEEK options available with BioWick X implants and all-suture option available with BioWick SureLock implant

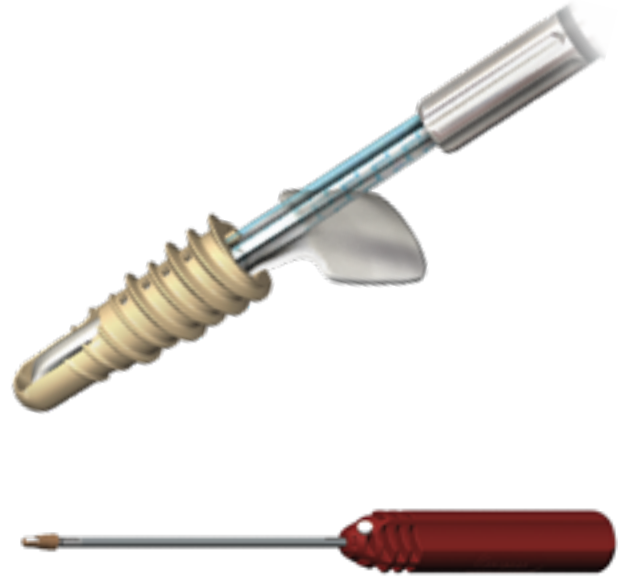

BioWick X Implants	
CM-6255	5.5 mm (PEEK), Double-Loaded with #2 suture
CM-6265	6.5mm (PEEK), Triple-Loaded with #2 suture

BioWick X Reusable Instruments	
CM-6201	Tap, 5.5 mm
CM-6202	Tap, 6.5 mm

BioWick SureLock Implant	
CM-6127	2.7 mm (All-Suture), Double-Loaded with #2 Suture

BioWick SureLock Instruments	
CM-6101	2.7 mm, Drill, Disposable
CM6101H	Hard Bone Drill, Disposable
CM-6120	Drill Guide, Reusable
CM-6121	Obturator, Reusable

Educational Materials

Ref. Number	Description
1511.1-US-en	BioWick – Interpositional Bioresorbable Scaffold Wick for Rotator Cuff Repair Brochure
1458.1-US-en	BioWick SureLock Implant Fact Sheet
71245 Rev A	BioWick X Implant Surgical Technique
2624.1-US-en	BioWick X Implant Handout
1049.1-US-en	BioWick X Implant Fact Sheet

Sample Products

Part Number	Description
MK8049701	2.7 mm BioWick SureLock Implant Sample

Shoulder Labral Repair

Knotless Anchor Systems

Quattro Link Knotless Anchor – 2.9 mm

Features

- Knotless techniques can minimize surgical steps and eliminate the possibility of knot impingement
- Surgeon controlled tensioning **after** anchor implantation provides the surgeon the ability to adjust **tissue restoration**
- Accepts two MaxBraid Sutures or two BroadBand Tape limbs



Quattro Link Knotless Anchor	
CM-9129	2.9 mm

Instruments	
CM-9300ST	Drill Bit, Disposable
CM-9324ST	Hard Bone Drill, Disposable
CM-9301	Drill Guide, Reusable
CM-9302	Obturator, Reusable
CM-9303	Offset Drill Guide

Educational Materials

Ref. Number	Description
1530.1-GLBL-en	Complete Shoulder Solutions Flyer
1456.1-UD-en	Quattro Shoulder System Innovative Labral Repair System – Bankart Repair - Simple Stitch
70330 Rev A	White Paper – Biomechanical Pullout Strength of Quattro X and Quattro Link Rotator Cuff Anchors
2736.1-US-en	Shoulder Labrum Portfolio

Sample Products

Part Number	Description
MK3407202	2.9 mm Knotless Anchor with Inserter Sample

Shoulder Labral Repair – Suture Anchor Systems

Quattro GL/GL2 Suture Anchors – 2.9 mm

Features

- PEEK push-in anchor with a straightforward implantation technique
- Single or double loaded anchors loaded with #2 suture
- Individual suture eyelets allow sutures to freely slide



Quattro GL/GL2 Suture Anchors	
CM-9329	2.9 mm, (1) #2 Suture
CM-9329GL2	2.9 mm, (2) #2 Sutures

Instruments	
CM-9300ST	Drill Bit, Disposable
CM-9324ST	Hard Bone Drill, Disposable
CM-9301	Drill Guide, Reusable
CM-9302	Obturator, Reusable
CM-9303	Offset Drill Guide

Educational Materials

Ref. Number	Description
1530.1-GLBL-en	Complete Shoulder Solutions Flyer
70331 Rev A	White Paper – Biomechanical Pullout Strength of Quattro GL Glenoid Labrum Repair Anchors
1498.1-GLBL-en	Quattro GL Suture Anchor SLAP Repair Surgical Technique
2736.1-US-en	Shoulder Labrum Portfolio

Sample Products

Part Number	Description
MK3400003	2.9 mm Suture Loaded Anchor with Inserter Sample

Shoulder Labral Repair – Soft Anchor Systems

JuggerKnot Soft Anchors – 1.4 mm & 1.5 mm

Features

- Single-loaded with #1 or #2 MaxBraid suture
- Smaller anchor allows minimal bone removal in the glenoid and provides for tissue to bone contact
- Smaller anchor allows for curved guide deployment which are designed to minimize the quantity of portals

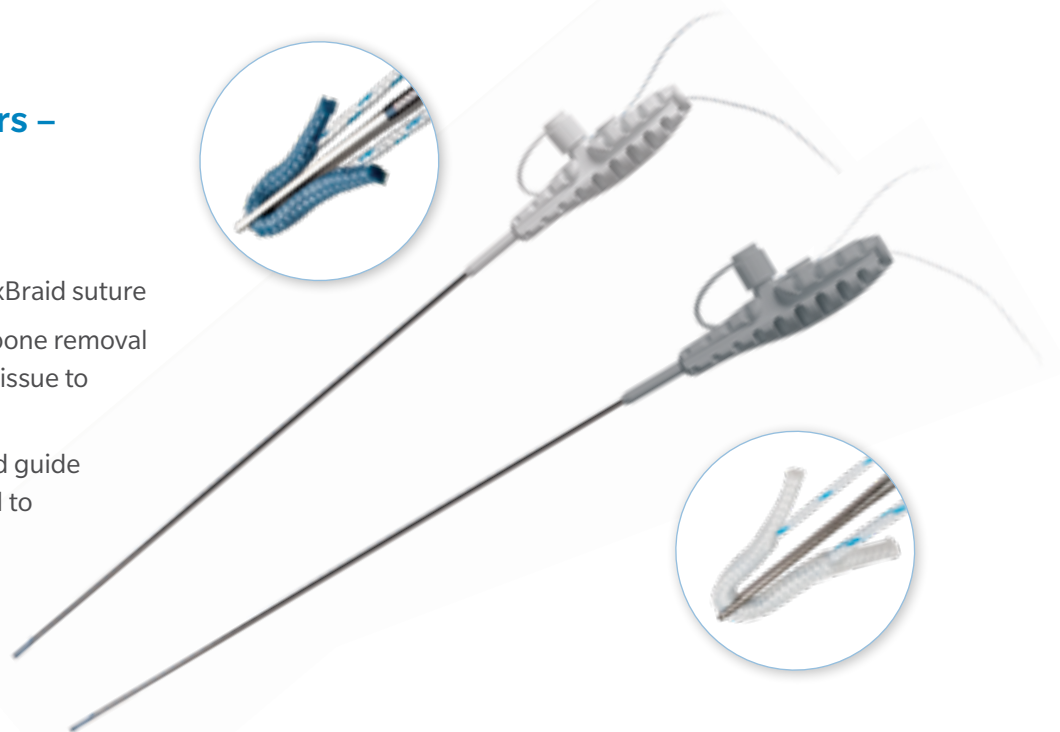

JuggerKnot 1.4 & 1.5 mm Soft Anchors	
912030	1.4 mm, (1) #1 MaxBraid Suture
912010	1.4 mm, (1) #1 MaxBraid Suture (10 Pack)
912000	1.4 mm System (2 Implants, Straight Guide, Drill Bit)
912031	1.5 mm, (1) #2 MaxBraid Suture
912015	1.5 mm, (1) #2 MaxBraid Suture (10 Pack)

Educational Materials

Ref. Number	Description
0394.1-GLBL-en-REV0416	Low Profile/Trans-Cuff SLAP Repair with the JuggerKnot Soft Anchor 1.4/1.5 mm (with Percutaneous Instrumentation)
0396.1-GLBL-en-REV0416	Low-Profile/Trans-Cuff PASTA Repair with JuggerKnot Soft Anchor 1.5 mm (with Percutaneous Instrumentation)
0393.1-GLBL-en-REV0416	JuggerKnot and JuggerKnotless Soft Anchor – All-Inclusive Brochure
2736.1-US-en	Shoulder Labrum Portfolio

Sample Products

Part Number	Description
912030S	1.4 mm JuggerKnot Sample
912030SR	1.4 mm JuggerKnot Reload Sample (10 Pack)
912031S	1.5 mm JuggerKnot Sample
912031SR	1.5 mm JuggerKnot Reload Sample (10 Pack)

JuggerKnot 1.4 mm and 1.5 mm disposables and instrumentation on following page.

Shoulder Labral Repair – Soft Anchor Systems

JuggerKnot Soft Anchor Instrumentation – 1.4 mm & 1.5 mm

1.4 mm Disposable Instrumentation

Part Number	Description	Components
912000	2 Implant Kit System	2 implants, guide, drill bit
912040	Disposable Straight Kit	Guide & drill bit
912040C	Disposable Curved Kit	Curved guide & flex drill bit
912040P	Disposable Percutaneous Kit	Guide, 13G guide pin & drill bit
912140C	Disposable Curved Kit with Centering Sleeve	Curved guide, centering sleeve, & flex drill bit
912045	Centering Sleeve Kit	Centering sleeve & drill bit
912036R	Large Shank Rigid Drill Bit	
912036	Flexible Spade Drill Bit	
912136	Sterile Flexible Spade Drill Bit	



Straight Guide



Curved Guide

1.5 mm Disposable Instrumentation

Part Number	Description	Components
912041	Disposable Straight Kit	Guide & drill bit
912041C	Disposable Curved Kit	Curved guide & flex drill bit
912141C	Disposable Curved Kit with Centering Sleeve	Curved guide, centering sleeve, & flex drill bit
912046	Centering Sleeve Kit	Centering sleeve & drill bit
912037R	Large Shank Rigid Drill Bit	
912037	Flexible Drill Bit	



Reusable Straight Fishmouth Guide

1.5 mm Reusable Instrumentation

Part Number	Description
912035	Reusable Straight Guide
912038	Reusable Straight Trocar
912038P	Reusable Percutaneous Trocar
912039	Reusable Obturator
912035C	Reusable Curved Guide
912038C	Flexible Trocar
912039C	Flexible Obturator



Centering Sleeve Drill Bit



Flexible Drill Bit

1.4 mm & 1.5 mm Sample Instrumentation

Part Number	Description	Components
912040S	1.4 mm Disposable Kit Sample	Guide, drill, obturator
912040CS	1.4 mm Curved Kit Sample	Curved guide, drill, obturator
912040PS	Percutaneous Kit Sample	Perc Guide, drill, guide pin, long trocar
912041S	1.5 mm Straight Kit Sample	Guide, drill, obturator
912041CS	1.5 mm Curved Kit Sample	Curved guide, drill, obturator



Rigid Drill Bit

Shoulder Labral Repair – Soft Anchor Systems

SureLock Soft Anchor – 1.4 mm

Features

- Inserter controlled deployment method for consistent anchor delivery
- Smaller soft anchor requires less bone removal than larger, hard anchors, leading to bone preservation and greater tissue-to-bone contact
- Curved guide allows closer anchor placement to the labrocartilage junction and "in-rim" positions further inferior and superior compared to larger anchors with straight instrumentation



SureLock All-Suture Anchor	
CM-9614F	1.4 mm, (1) #2 Sutures

Instruments	
CM-9640	Drill Bit, Disposable
CM-9640S	Drill with Centering Sleeve, Disposable
CM-9641	Obturator, Reusable
CM-9643	Straight Drill Guide, Reusable
CM-9645	Curved Drill Guide, Reusable

Educational Materials

Ref. Number	Description
1453.1-GLBL-en	SureLock All Suture Anchor System Surgical Technique Guide for Bankart Repair
1454.1-GLBL-en	SureLock All Suture Anchor System
1530.1-GLBL-en	Complete Shoulder Solutions Flyer
2736.1-US-en	Shoulder Labrum Portfolio

Sample Products

Part Number	Description
MK8021401	1.4 mm Suture Anchor Sample

Shoulder Labral Repair – Soft Anchor Knotless Systems

JuggerKnotless Soft Anchor – 2.1 mm

Features

- Loaded with #1 MaxBraid suture
- Combines JuggerKnot and ZipLoop technology for a knotless construct
- Gives the surgeon the ability to control the tension of the anchor with his or her hands

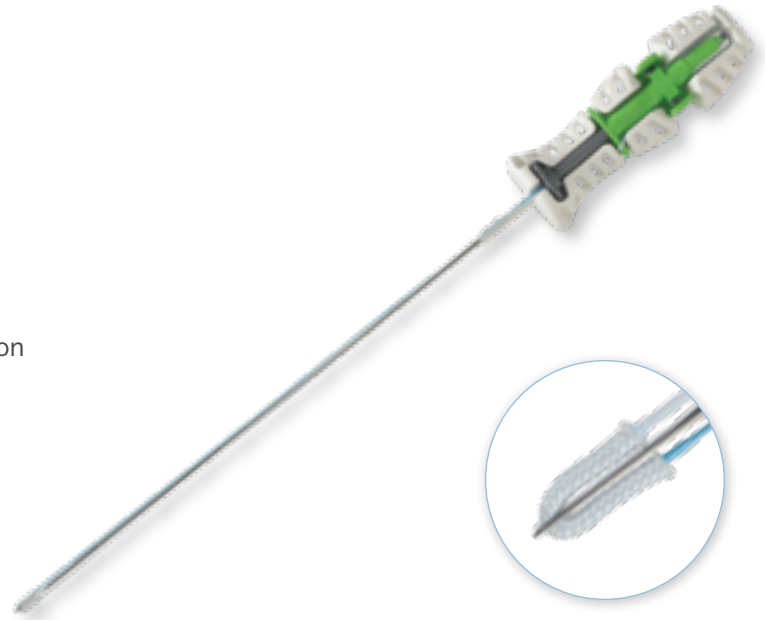

JuggerKnot Soft Anchors	
110005198	2.1 mm, #2 MaxBraid
110005199	2.1 mm (10 Pack)

Instrumentation	
110003172	Disposable Straight Kit (2.1 mm Guide & Drill Bit)
110003182	Drill Bit, Disposable
110017433	Trocar, Reusable
110017434	Obturator, Reusable
110017436	Fishmouth Guide, Reusable
110003181	Four-Prong Guide, Reusable

Educational Materials

Ref. Number	Description
0393.1-GLBL-en-REV0416	JuggerKnot and JuggerKnotless Soft Anchor All-Inclusive Brochure
2736.1-US-en	Shoulder Labrum Portfolio

Sample Products

Part Number	Description
110003165	JuggerKnotless Implant Sample
110005200	JuggerKnotless Reload Sample (5 Pack)

AC Joint Reconstruction/ Reduction

AC Joint ZipTight System

Features

- 2 button system with ZipLoop technology creating a knotless repair
- Size #7 Suture



AC Joint ZipTight System	
904834	AC Joint ZipTight implant with ZipLoop
904835	AC Joint ZipTight Implant with Double ZipLoop

AC Joint ZipTight System	
904776	ZipLoop Puller
904837*	Procedure System, Disposable*
909846**	ToggleLoc Disposable Kit**
909864	ToggleLoc Pusher, Disposable
948084	3.2 mm Cannulated Drill

* Procedure System Contains:

ToggleLoc Pusher and Plunger, 6" Beath Pin, 4.5 mm ToggleLoc Cannulated Drill, & 2.4 mm Drill Point K-Wire (10")

** ToggleLoc Disposable Kit Contains:

2.4 mm x 13" Drill Point K-Wire, 2.4 mm x 16" Graft Passing Pin, ToggleLoc 4.5 mm Drill Bit, 2.4 mm x 10" Drill Point K-Wire, 3.2 mm Drill Bit, & ACL Bone Plug

Educational Materials

Ref. Number	Description
0388.1-GLBL-en-REV0816	Acute AC Joint Reconstruction with ZipTight Fixation System
0389.1-US-en-REV0516	Chronic Anatomic AC Joint Reconstruction with ZipTight Fixation Device with ZipLoop Technology

Sample Products

Part Number	Description
904834S	ZipTight Acute Sample
904835S	ZipTight AC Chronic Sample

Biceps Repair

In-Lay Repair Systems

Quattro Bolt Tenodesis Screws

Features

- Creates a tendon-in-socket fixation
- Tendon preservation is achieved with the smooth distal tip screw design utilizing a pound-in/screw-in technique
- Mini-open and arthroscopic techniques achievable when the Lock-Stitch Suture Passer is utilized



Quattro Bolt Tenodesis Screws	
CM-9505	5 mm x 10 mm
CM-9506	6 mm x 12 mm
CM-9507	7 mm x 14 mm
CM-9508	8 mm x 16 mm
CM-9509	9 mm x 16 mm

Instruments	
CM-9500	Lock-Stitch Procedure Kit (1 Suture Needle & 2 TRU-Loop #2 Suture Loops)
CM-9010LS	Lock-Stitch Passer
CM-9540	4 mm Drill Kit (1.4 mm drill pin, drill)
CM-9550	5 mm Drill Kit (1.4 mm drill pin, drill)
CM-9560	6 mm Drill Kit (2.4 mm drill pin, drill)
CM-9570	7 mm Drill Kit (2.4 mm drill pin, drill)
CM-9580	8 mm Drill Kit (2.4 mm drill pin, drill)

Educational Materials

Ref. Number	Description
1455.1-GLBL-en	Quattro Bolt – Tenodesis Screw – Proximal Biceps Repair Surgical Technique Guide
1499.1-US-en	Quattro Bolt – Tenodesis Screw – Flexor Hallucis Longus (FHL) Tendon Transfer Surgical Technique
1530.1-GLBL-en	Complete Shoulder Solutions Flyer

Sample Products

Part Number	Description
MK4018806	Quattro Bolt Anchor, 7 mm Tenodesis PEEK Screw Sample

Biceps Repair – In-Lay Repair Systems

ToggleLoc 2.9 mm Fixation System

Features

- Simplified technique with the first preloaded button on the inserter handle for easy insertion
- Minimally invasive procedure with a small 2.9 mm drill hole and no need for interference screw fixation
- Efficient system with a slotted reamer that can serve as an insertion guide
- Designed to provide confidence for consistent push button deployment
- Designed to minimize potential to penetrate the soft tissues on posterior elbow



ToggleLoc 2.9 mm Implants

110010384	2.9 mm ToggleLoc without Needles
110017308	2.9 mm ToggleLoc with Needles

Instruments

110027357	Disposable Cannula Kit (Clear Drill Guide, 2.9 mm Guide Pin)
110018275	5.0 mm Slotted Reamer
110010371	6.0 mm Slotted Reamer
110010372	7.0 mm Slotted Reamer
110010373	8.0 mm Slotted Reamer
110018366	7.0 mm Step Reamer
110017271	2.9 mm Guide Pin

Sutures

110003540	ExpressBraid White (Single)
110003539	ExpressBraid Blue/White (Single)
110003463	ExpressBraid White (10 Pack)
110003464	ExpressBraid Blue/White (10 Pack)
900333	#2 MaxBraid White, Tapered HC-5 Needles
900334	#2 MaxBraid Blue, Tapered HC-5 Needles
900335	#2 MaxBraid Blue, Tapered C-7 Needles

Educational Materials

Ref. Number	Description
0063.1-GLBL-en-REV0216	Distal Biceps Tendon Reattachment with the ToggleLoc 2.9 mm Soft Tissue Fixation Device
1127.1-GLBL-en-REV0817	ToggleLoc 2.9 mm All Inclusive Brochure
0033.1-GLBL-en-REV1215	Open Subpectoral Biceps Tenodesis with the ToggleLoc 2.9 mm Soft Tissue Fixation Device

Sample Products

Part Number	Description
110010372S	7.0 mm JugglerLoc Slotted Reamer Sample
110017271S	2.9 mm JugglerLoc Guide Pin Sample
110010384S	2.9 mm ToggleLoc Sample
110017308S	2.9 mm ToggleLoc with Needles Sample

Biceps Repair – In-Lay Repair Systems

ToggleLoc 4.5 mm Fixation System

Features

- Allows for circumferential healing
- Smaller hole when compared with interference screw fixation
- ZipLoop technology and 4.5 mm titanium button provide suspensory fixation



ToggleLoc Elbow Implants	
904753	4.5 mm #7 PE ZipLoop
909854	System Kit (Implant, 2.4 mm guide pin, 4.5 mm reamer, 1 MB suture with 1 needle)
909874	System (Implant, 2.4 mm drill pin, 4.5 mm reamer, 2 MB sutures with 2 needles, pusher/plunger)
909864	ToggleLoc Pusher Plunger

Educational Materials

Ref. Number	Description
BMET0558.0-GBL REV0714	Distal Biceps Percutaneous Surgical Technique

Biceps Repair – In-Lay Repair Systems

JuggerLoc 2.3 mm Pull Through

Features

- Combines JuggerKnot and ZipLoop technologies to form a tendon-in-socket, knotless suspensory fixation utilizing a soft button
- Minimally invasive procedure with a 2.3 mm drill hole and no need for interference screw fixation



JuggerLoc Pull Through	
110017362	2.3 mm
110010382	2.3 mm with Needles

Instruments	
110027357	Disposable Cannula Kit (Clear Drill Guide, 2.9 mm Guide Pin)
110018275	5.0 mm Slotted Reamer
110010371	6.0 mm Slotted Reamer
110010372	7.0 mm Slotted Reamer
110010373	8.0 mm Slotted Reamer
110018366	7.0 mm Step Reamer
110018412	2.3 mm Guide Pin

Sutures	
110003540	ExpressBraid White (Single)
110003539	ExpressBraid Blue/White (Single)
110003463	ExpressBraid White (10 Pack)
110003464	ExpressBraid Blue/White (10 Pack)
900333	#2 MaxBraid White, Tapered HC-5 Needles
900334	#2 MaxBraid Blue, Tapered HC-5 Needles
900335	#2 MaxBraid Blue, Tapered C-7 Needles

Educational Materials

Ref. Number	Description
0375.1-US-en-REV0216	Insertion Instructions with the JuggerLoc Soft Tissue Anchor for a Pull Through Technique
0376.1-US-en-REV0416	Insertion Instructions for the JuggerLoc Soft Tissue Anchor Technique with Needles

Sample Products

Part Number	Description
110017362S	2.3 mm JuggerLoc Soft Tissue Pull Through Sample
110010382S	2.3 mm JuggerLoc with Needles Pull Through Sample

Biceps Repair – On-Lay Repair Systems

JuggerLoc 2.9 mm Unicortical

Features

- Enables surgeons to perform a quick and reproducible on-lay tenodesis
- Utilizes two proven technologies: JuggerKnot 2.9 mm and ZipLoop Technology
- Provides a knotless fixation of the LHB tendon without the need for an interference screw or whipstitching of the tendon



JuggerLoc Unicortical Implant

110017314	2.9 mm Unicortical
-----------	--------------------

Instruments

110005306	2.9 mm Short Drill Bit
110016951	2.9 mm Short Reusable Guide

Educational Materials

Ref. Number	Description
0378.1-US-en-REV0116	Insertion Instructions with the JuggerLoc Soft Tissue Anchor

Sample Products

Part Number	Description
110017314S	2.9 mm JuggerLoc Unicortical Fixation Sample

Biceps Repair – On-lay Repair Systems

Snapshot Fixation System

Features

- Mini-open technique facilitating a subpectoralis proximal biceps repair
- No tendon prep, suturing, or knot tying
- Accomplishes a quick onlay – biceps tenodesis in the prepared bicipital groove



Snapshot Fixation System	
110019010	Mini Open Kit (Loaded gun with implant, drill bit, clear guide)
110018165	Arthroscopic Kit (Loaded gun with implant, drill bit, cannula with teeth)
110018166	SnapShot Implant Reload

110024938	Snapshot Drill, Disposable
-----------	----------------------------

Educational Materials

Ref. Number	Description
0379.1-GLBL-en-REV1216	Athrosopic Biceps Tenodesis – Using the SnapShot Fixation System

Sample Products

Part Number	Description
110018166S	Snapshot Reload Sample
110018844	SnapShot Reloads Sample, PEEK Implant only (5 Pack)
110018165S	Snapshot Full Kit Sample

Small Bone & Joint

Soft Anchor Systems

JuggerKnot Mini 1.0 mm Soft Anchor

Features

- The smallest anchor on the market due to its all-suture material
- Designed for hand and wrist procedures
- Includes two T-28 tapered needles to aid in soft tissue reattachment



JuggerKnot Mini Soft Anchor	
912076	1.0 mm Mini, (1) 2-0 MB Suture, tapered needles (includes drill bit)
912080	1.0 mm Mini, (1) 2-0 MB Suture (10 Pack, includes drill bits)
912082	1.0 mm Mini, (1) 3-0 MB Suture, tapered needles (includes drill bit)
912084	1.0 mm Mini, (1) 3-0 MB Suture (10 Pack, includes drill bits)

Instrumentation	
912077	1.0 mm JuggerKnot Mini Step Drill (Single Use)

Educational Materials

Ref. Number	Description
0397.1-GLBL-en-REV0916	Scapholunate Ligament Repair/Reconstruction with JuggerKnot Soft Anchor – 1.0 mm Mini Surgical Technique
0393.1-GLBL-en-REV0416	JuggerKnot and JuggerKnotless Soft Anchor – All-Inclusive Brochure

Sample Products

Part Number	Description
912076S	JuggerKnot 1.0 mm Mini 2-0 Sample (3 Pack)
912082S	JuggerKnot 1.0 mm Mini 3-0 Sample (3 Pack)

Small Bone & Joint – Soft Anchor Systems

JuggerKnot Soft Anchor – 1.4 mm Short

Features

- Designed for small bone and joint applications in the elbow, and foot and ankle
- Designed specifically for open procedures with tapered #5 needles
- Single loaded with a #1 MaxBraid Suture



JuggerKnot 1.4 mm Short	
912068	JuggerKnot 1.4 mm Short, (1) #1 MB, tapered needles
912069	JuggerKnot 1.4 mm Short #1 (10 Pack)

Instrumentation	
912071	Sterile Disposable Drill Bit
912072	Reusable Guide
912073	JuggerKnot 1.4 mm Short Disposable Kit with Guide and Drill Bit
912075	JuggerKnot 1.4 mm Short Disposable Kit with Implant and Guide

Educational Materials

Ref. Number	Description
0393.1-GLBL-en-REV0416	JuggerKnot and JuggerKnotless Soft Anchor – All-Inclusive Brochure
BMET0538.0-GBL • REV0714	JuggerKnot 1.4 mm Short Data Sheet
BMET0539.0-GBL • REV0714	JuggerKnot Soft Anchor Lateral Ankle Ligamentous Instability Surgical Protocol
BMET0263.0-GBL • REV0714	JuggerKnot Soft Anchor – 1.4 mm Short – Lateral Epicondylitis Repair Surgical Technique

Sample Products

Part Number	Description
912068S	1.4 mm JuggerKnot Short Sample

Small Bone & Joint – Soft Anchor Systems

JuggerKnot Short Soft Anchors – 1.45 mm Short Rigid

Features

- Rigid design eliminates the need for a guide, allowing surgeons to control the depth of anchor insertion
- Designed specifically for soft tissue to bone open procedures with tapered #5 needles
- Single loaded with a #1 blue/white or #2 blue MaxBraid Suture

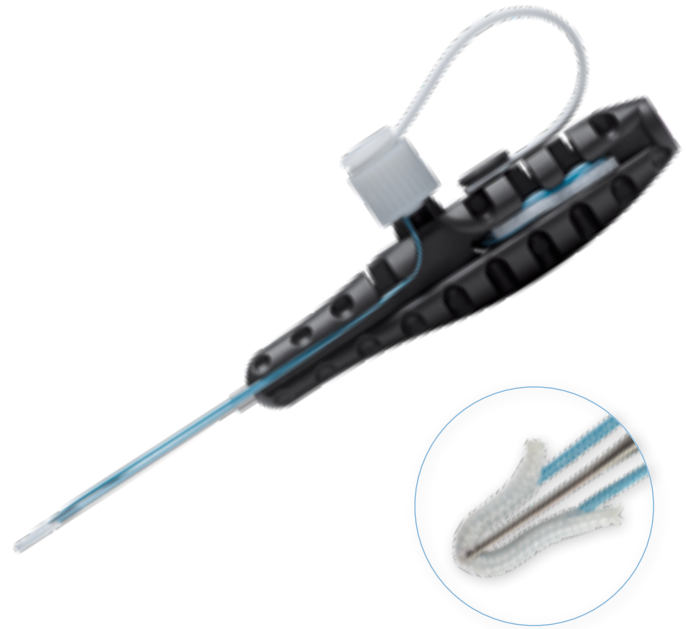

JuggerKnot 1.45 mm Rigid	
110005307	1.45 mm Short Rigid, (1) #1 MB, tapered needles (includes drill bit)
110005315	1.45 mm Short Rigid, (1) #2 MB (includes drill bit)
110005319	1.45 mm Short Rigid, (1) #1 MB (10 Pack)
110005320	1.45 mm Short Rigid, (1) #2 MB (10 Pack)

Instrumentation	
912071	Sterile Disposable Drill Bit
912072	Reusable Guide
110005323	Rigid Drill Bit (5 Pack)

Educational Materials

Ref. Number	Description
0393.1-GLBL-en-REV0416	JuggerKnot and JuggerKnotless Soft Anchor – All-Inclusive Brochure
BMET0797.0-GBL • REV0614	JuggerKnot Short Rigid Soft Anchor Flyer

Sample Products

Part Number	Description
110005307S	JuggerKnot Short Rigid #1 MB, Sample
110005315S	JuggerKnot Short Rigid #2 MB, Sample

1. Email Chain Data on file at Biomet Sports Medicine.

Suture Passing Instrumentation

Quattro Suture Passers

Features

- **Reliable:** The internal design of the hand-piece in conjunction with the specifically designed needles allow for a smooth and consistent pass
- **Versatile:** Three top jaw options for both mini-open and arthroscopic repairs
 - Quattro GTS Passer (CM-9010GTS)/ Quattro GT Passer (CM-9010GT): Pass & retrieve
 - Quattro Passer (CM-9010): Non-capturing
 - The Quattro GTS Passer (CM-9010GTS) offers a side loading/blunt front end design to reduce the likelihood of catching soft tissue or other sutures in the front of the instrument
- **Low Profile Design:** Fits down a 6.5 mm cannula



Quattro GT Needle

Quattro Suture Passers	
CM-9010	Quattro GT Passer (Non-Capturing)
CM-9010GT	Quattro GT Passer
CM-9010GTS	Quattro GTS Side Loading Passer
CM-9011	Quattro GT Needle
CM-9500	Quattro Tru-Loop Kit

Quattro Tru-Loop Kit Includes:

- 2 TRU-LOOP® Sutures (CM-9500) (suture loop with a tail end), #2 High Strength Suture
- 1 Suture Passer Needle

Educational Materials

Ref. Number	Description
1460.1-US-en-REV0717	Upper Extremities Instrumentation Brochure – Sports Medicine Arthroscopy

Suture Passing – Disposable Instrumentation

Lock-Stitch Suture Passer

Features

- Offers a method for passing suture through tubular tendons like the biceps
- Innovative: The rounded jaw design allows for easily grasping and passing suture through the biceps tendon
- Versatile: Offering options for passing suture through tendons in the shoulder, elbow, knee, and foot and ankle. The kit is a reliable option to create a cinching knot, securing the biceps tendon for repair.

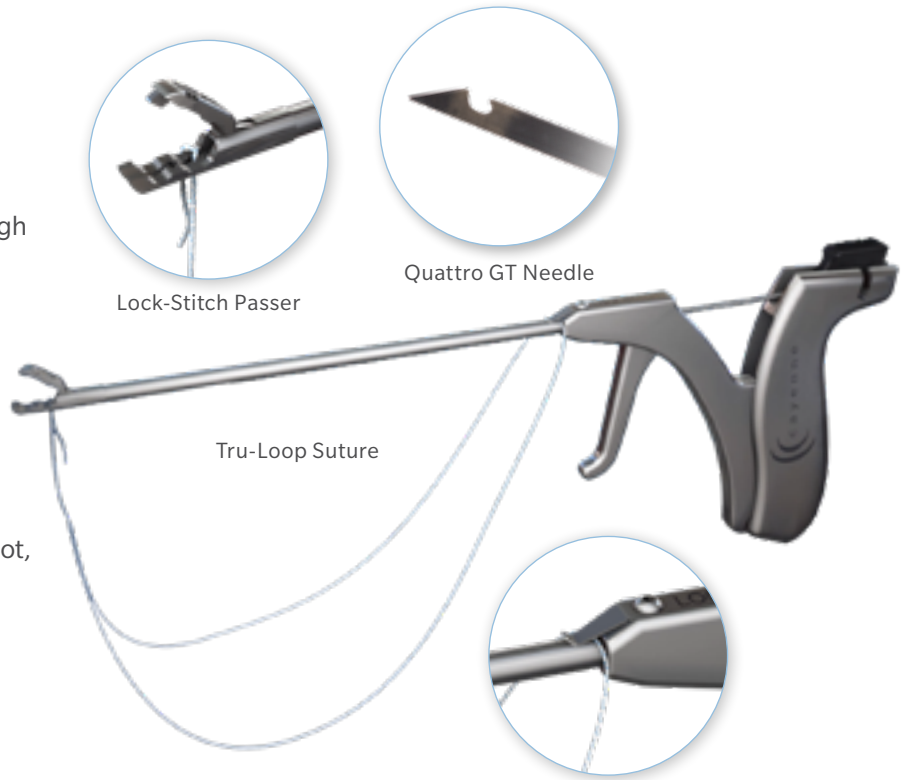

Lock-Stitch Suture Passer	
CM-9010LS	Lock-Stitch Suture Passer
CM-9011	Quattro GT Needle
CM-9500	Quattro Tru-Loop Kit

Educational Materials

Ref. Number	Description
1460.1-US-en-REV0717	Upper Extremities Instrumentation Brochure – Sports Medicine Arthroscopy

Quattro Tru-Loop Kit Includes:

- 2 TRU-LOOP Sutures (CM-9500) (suture loop with a tail end), #2 High Strength Suture
- 1 Suture Passer Needle

Suture Passing – Disposable Instrumentation

EZPass Suture Passing System

Features

- **Easy Visualization:** Kite shaped shuttle wire opens wide inside the joint
- **Braided Nitinol:** Designed with an oxide coating to minimize the friction transferred to soft tissue
- **Tip Geometry:** Sharp, low profile tips designed to ease tissue penetration and minimize tissue trauma
- **Design Features:** Thumb wheel allowing for quick and easy advancement of the Nitinol passing kite



EZPass Suture Passers	
904050	90° Up (Black Handle)
904051	45° Up (Grey Handle)
904052	45° Medium Up (Dark Blue Handle)
904053	70° Right (Yellow Handle)
904054	70° Left (Red Handle)
904055	30° Right (Light Blue Handle)
904056	30° Left (Green Handle)

Educational Materials

Ref. Number	Description
1460.1-US-en-REV0717	Upper Extremities Instrumentation Brochure – Sports Medicine Arthroscopy



45° Medium Up
(Dark Blue Handle)
904052



90° Up
(Black Handle)
904050



45° Up
(Grey Handle)
904051



70° Right
(Yellow Handle)
904053



70° Left
(Red Handle)
904054



30° Right
(Light Blue Handle)
904055



30° Left
(Green Handle)
904056

Suture Passing – Disposable Instrumentation

SpeedSnare Suture Passer System

Features

- 1.8 mm tip designed to minimize tissue damage during tissue penetration without compromising the strength of the device
- The first system designed with both “suture locked” and “suture sliding” positions
- Pass and retrieve in one step (accepts MaxBraid suture and BroadBand suture tape)

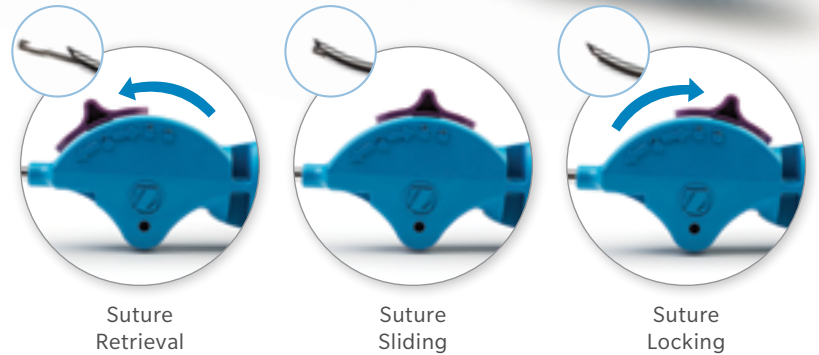

SpeedSnare Suture Passers	
110030129	30 ° Up (Purple)
110030130	60 ° Up (Black)
110030131	30 ° Right (Yellow)
110030132	30 ° Left (Red)
110030133	Straight (White)

Educational Materials

Ref. Number	Description
1460.1-US-en	Upper Extremities Instrumentation Brochure
1414.1-GLBL-en	SpeedSnare Suture Passer Flyer

Upper Extremities General Instrumentation

Shoulder Instrumentation Trays

Features

- General instrumentation case for easy transport
- Can hold up to 12 hand instruments, customizable to surgeon preference
- Does not accommodate Quattro suture passers



904850	Arthroscopic Shoulder Tray
904852	Hand Instrument Only Tray



Upper Extremities – Soft Tissue Suture Passing Instruments

Precision II Arthropasser Suture Passers

Penetrating Suture Graspers



Arthropasser
910075 **Straight**



Arthropasser PII
910080 **45°, Left**



Sixter Right
328312BSM



**Penetrating Grasper
Straight**
398300BSM



Arthropasser
910076 **45°, Up**



Arthropasser PII
910081 **45°, Right**



Sixter Left
328322BSM



Penetrating Grasper Right
398311BSM



Arthropasser PII
910079 **Straight**



Arthropasser PII
910082 **35°, Up**



Clever Hook Right
328332BSM

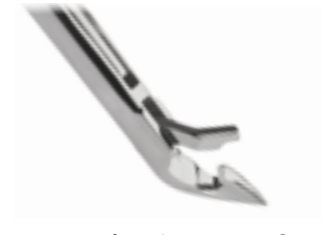

Penetrating Grasper Left
398321BSM



Clever Hook Left
328342BSM



Penetrating Grasper 30° Up
398331BSM

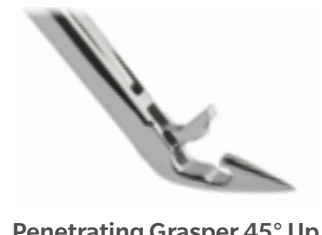

Penetrating Grasper 45° Up
398341BSM

Upper Extremities – Soft Tissue Grasper Instruments

Tissue Graspers



**Tissue Grasper
with Ratchet**

397300BSM



**Grasper, Straight Tip,
Alligator Larger**

910060 **3.8 mm
Bite Width**



Suture Grasper

604210BSM



**Grasper, Straight Tip,
Loose Body**

910061 **3.4 mm
Bite Width**



**MultiGrasper
Tissue/Suture Grasper**

910063

Tissue Rongeur













Cupped Rongeur

910062 **4 mm Bite**

Upper Extremities – Soft Tissue Debridement Instruments

Legacy (PII) Biters, Side Biters, Back Biters & Scissors

			
Bite Punch, 15° Up Tip	Bite Punch, Straight Tip	Bite Punch, 15° Up Tip	Side Biters, Rotary Punch, 90° Tip, Right, Loop
910030 1.7 mm	910040 2.6 mm	910045 3.6 mm, Right	910053 3.2 mm Bite Width
			
Bite Punch, 15° Up Tip	Bite Punch, 15° Up Tip	Bite Punch, 15° Up Tip	Round Back Biters Punch, Straight Tip, Retro Left
910031 1.7 mm, Left	910041 2.6 mm	910046 3.6 mm, Up	910050 2.4 mm Bite Width
			
Bite Punch, 15° Up Tip	Bite Punch, Straight Tip	Round Bite Punch, Straight Tip	Round Back Biters Punch, Straight Tip, Retro Right
910032 1.7 mm, Right	910042 3.6 mm	910047 5 mm, Right	910051 2.4 mm Bite Width
			
Bite Punch, 15° Up Tip	Bite Punch, 15° Up Tip	Side Biters, Rotary Punch, 90° Tip, Left, Loop	MicroShears PII
910033 1.7 mm, Blunt Nose	910043 3.6 mm	910052 3.2 mm Bite Width	910072
			
	Bite Punch, 15° Up Tip		
	910044 3.6 mm, Left		

UPPER INSTRUMENTATION

Upper Extremities – Bone and Tissue Preparation Instruments

Elevators & Rasps



Rasp Up Bend 20°

901131BSM



Rasp Down Bend 20°

901141BSM



**Tissue Liberator
Blade Up**

902100BSM



**Tissue Liberator
Blade Down**

902141BSM

Charlotte Shoulder Set



15° Smooth Elevator

904800



**15° Charlotte Rasp/
Elevator**

903719



30° Smooth Elevator

904801



15° SLAP Elevator

904803



15° Bankart Rasp

904804

Upper Extremities – Suture Management Instruments

Suture Graspers (Retrievers)



Suture Manipulator Grasper

601200BSM



Suture Grasper

604210BSM

Legacy Precision II



Vampire™ Suture Grasper

910083



MultiGrasper Tissue/Suture Grasper

910063

Knot Pushers



Knot Manipulator, Large Hole

301200BSM



Shoulder Knot Manipulator

303200BSM



Closed Knot Pusher, Small Hole

902813



Open Ended Knot Pusher

902803

Suture Cutters



Suture Cutter Trim Cord

231210BSM **2 mm tail**

Cuts up to 2 limbs of suture



Multi Suture Cutter

231220BSM **1 mm tail**

Cuts up to 4 limbs of suture



Flush Suture Cutter

910086 **No tail**

Cuts up to 2 limbs of suture



Slotted MaxCutter Suture Cutter

904808

Cuts up to 2 limbs of suture

Upper Extremities – Miscellaneous Instruments

Probe/Crochet Hook



Probe
901010



Crochet Hook
201200BSM

Charlotte Shoulder System Tray 2 – Portal Placement/Misc.



Probe
901010



Curved Rasp with Elevator
903719

Fluid Management

Cannulas

HydroDam Cannulas

Features

- Seal design with 1 slit and support ribs ①
- Translucent body allows easy access for instrumentation and suture visualization ②
- Dual seal designed to facilitate smooth implant or instrument passage with minimal leakage
- Turn key design for out flow of fluid
- Multiple sizes and lengths for hip and shoulder

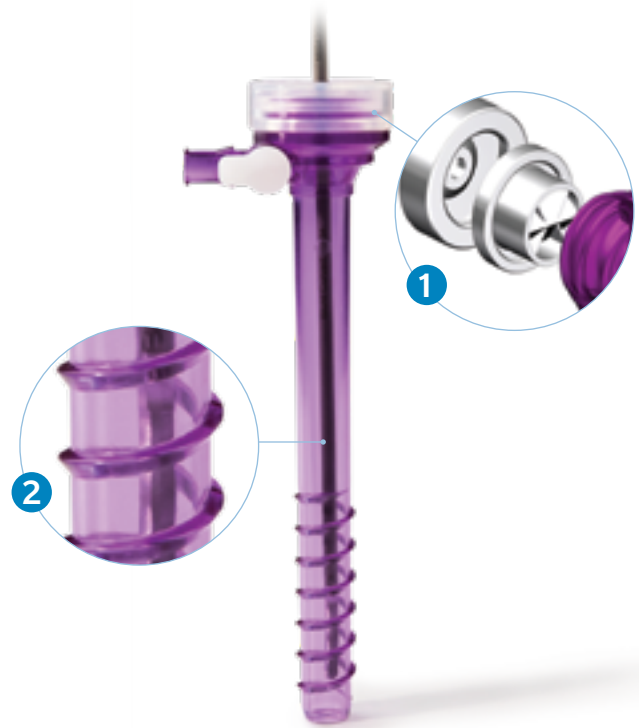

Cannulas, Single	
110025590	Rigid 7 x 75 mm, includes Disposable Obturator
110025592	Rigid 8.5 x 75 mm, includes Disposable Obturator
110025596	Rigid 7 x 85 mm, includes Disposable Obturator
110025598	Rigid 8.5 x 85 mm, includes Disposable Obturator
110030950	Rigid 8.5 x 130 mm
110019086	Rigid 8.5 x 115 mm
110019090	Rigid 8.5 x 100 mm

Educational Materials

Ref. Number	Description
1415.1-GLBL-en-REV0717	HydroDam Cannula System – Don't Go With The Flow
1460.1-US-en-REV0717	Upper Extremities Instrumentation Brochure – Sports Medicine Arthroscopy



Fluid Management – Instruments

HydroDam Instrumentation

Features

- The first cannula system with a universal obturator
- Multiple sizes and lengths for hip and shoulder
- Cannulation with size



HydroDam	
110028430	Reusable Modular Obturator Handle
110028432	7 mm Reusable Obturator Shaft
110028433	8.5 mm Reusable Obturator Shaft
903720	3.2 mm Switching Stick
754420fbsm	4.0 mm Cannulated Switching Stick

Educational Materials

Ref. Number	Description
1415.1-GLBL-en-REV0717	HydroDam Cannula System – Don't Go With The Flow
1460.1-US-en-REV0717	Upper Extremities Instrumentation Brochure – Sports Medicine Arthroscopy

Fluid Management – O.R. Floor Mat

Absorb-O-Mat Disposable O.R. Floor Mats

Features

- Wicking, absorption and retention capabilities
- Does not release fluids when stepped on
- O.R. floor mat, prevents the mat from slipping, providing additional safety
- Various sizes and shapes let you choose the best configuration suited to your application
- One square foot absorbs one liter of fluid



Absorb-O-Mat O.R. Floor Mats	
902103	24 x 48 Case of 12
902104	24 x 48 Case of 24
902105	48 x 48 Case of 6
902106	48 x 48 Case of 12
902103S	24 x 48 Single
902105S	48 x 48 Single
902106S	48 x 48 Case Single
902111	6 x 6 Trial Pack of 25

Capital Equipment

Capital Equipment – Diagnostic Device

InnerVue Diagnostic Scope System

Features

- Xenon Fiber Optic Light Source delivers near 175-watt illumination
- 6.4" LCD monitor delivers high resolution video quality with multiple output options to connect to larger external monitors, video printers, and recording devices
- The disposable InnerVue Diagnostic Scope is micro-invasive, with an outside diameter of 1.2 mm (~18 gauge needle)

InnerVue Diagnostic Scope System	
922103	InnerVue II System
922180	85 mm, 10 Degree Scope Kit
922142	100 mm, 10 Degree Scope Kit

Scope Kit Includes:

Scope, Scope Drape, Cannula, Luer-Lock Cap, Trocar, Obturator, Cannula Plug



DELETE THIS PAGE

DELETE THIS PAGE

All content herein is protected by copyright, trademarks and other intellectual property rights, as applicable, owned by or licensed to Zimmer Biomet or its affiliates unless otherwise indicated, and must not be redistributed, duplicated or disclosed, in whole or in part, without the express written consent of Zimmer Biomet.

Confidential information intended solely for Zimmer Biomet employees, the Zimmer Biomet sales force, and authorized representatives. Distribution to any other recipient is prohibited.

©2020 Zimmer Biomet



1759.1-US-en-REV0120

 **Legal Manufacturer**
Biomet Sports Medicine
P.O. Box 587
56 E. Bell Drive
Warsaw, Indiana 46581-0587
USA

 **Legal Manufacturer**
Cayenne Medical, Inc.
16597 N. 92nd St., Suite 101
Scottsdale, AZ 85260
USA

 **Legal Manufacturer**
T.A.G. Medical Products
Corporation LTD
Kibbutz Gaaton 2513000
Israel
Tel: +972-4-9858400
Fax: +972-4-9858404

 **Legal Manufacturer**
Teleflex Medical
2015 Carrington Mill Blvd.
Morrisville, NC 27560
USA

 **Legal Manufacturer**
SBM SAS
Z.I du Monge
65100 LOURDES
France

zimmerbiomet.com

DELETE THIS PAGE

